

FAIRCHILD

EQUALIZER CARD w/REMOTE CONTROL PANEL

STEREO EQUALIZER CARD w/REMOTE CONTROL PANEL

MODEL 692EQ

MODEL 692EQ/ST

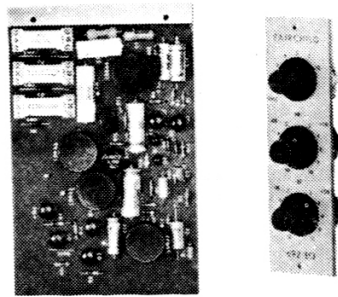

INSTRUCTION MANUAL

IB692EQ/568

FAIRCHILD MODEL 692EQ and 692EQ/ST

PROGRAM EQUALIZERS

DESCRIPTION

The MODEL 692EQ is a unique, remote-controllable equalizer/amplifier, capable of controlling the frequency response of a circuit over the entire audio spectrum, and providing up to 10 db boost and droop at low and high frequencies. The stereo version of this unit is the Model 692EQ/ST.

The 692EQ is designed to operate from levels as low as -40 db and provides up to 20 db of amplification with a maximum power handling capability of 18 dbm.

CIRCUIT DESCRIPTION

The 692EQ is an amplifier with an equalizer built into its negative feedback loop. The equalizer is controlled by means of LDRs (light dependent resistors), which in turn are driven by four transistors the control of which is provided by externally located potentiometers. These potentiometers control the current through the transistors, thereby changing illumination of the light source affecting light sensitive elements in the feedback loop. Amount of equalization is thereby changed in a noise-free manner and without steps.

All light sources are plug-in bulb (GE380). When light sources are OFF, frequency response of the amplifier is flat, providing amplifier/equalizer failsafe feature.

High frequency boost is accomplished by a tuned LC circuit in the feedback loop. Response of this circuit can be selected through a high frequency boost selector switch, which provides 10 db rise in response at 3, 4, 5, 7 and 10K Hz. Frequency response is accomplished through the use of three reed relays located on the card and controlled from the remote location using a five position three pole switch. Switching between the three relays selects the above mentioned frequencies.

SPECIFICATIONS

INPUT IMPEDANCE	10K
OUTPUT IMPEDANCE	3 ohms (150 ohm load or higher)
GAIN	20 db maximum
RESPONSE	From 20 to 20K Hz \pm 1 db -10 db down at 10,000 Hz 0 to 10 db boost at 3/4/5/7/10KHz

SPECIFICATIONS (cont'd)

DISTORTION2% maximum
NOISE	125 db in respect to input (equalizer set flat)
POWER CONSUMPTION	6 mils at 24V DC - 80 ma at 6.3VDC maximum
	Power required for relays 20ma at 24V max (all relays actuated)

MOUNTING

The 692EQ can be mounted with other INTEGRA II 692 series components using the 692RM rack mount, or it can be mounted in the 692SCH single card holder and installed in the 662RM rack frame for rack mounting. The remote actuator for the 92EQ is on a 5¼"Hx1½"W plate for FAIRCHILD console shell mounting, or unmounted for customer installation by other means.

CONNECTIONS

PIN 1 (A)	+24DC (relays)
PIN 2 (B)	SW1 relay - remote switch connection
PIN 3 (C)	SW2 relay - remote switch connection
PIN 4 (D)	SW3 relay - remote switch connection
PIN 5 (E)	Low frequency droop control (low frequency remote control)
PIN 6 (F)	High frequency circuit control (to high frequency remote control actuator)
PIN 7	NC
PIN 8	NC
PIN 9 (K)	Negative 6.3V DC
PIN 10 (L)	High frequency boost control (to high frequency boost remote actuator)
PIN 11 (M)	+6.3V DC
PIN 12 (N)	Low frequency boost control (to low frequency boost remote actuator)
PIN 13 (P)	Ground (amplifier input and output low) -24V DC

CONNECTIONS (cont'd)

PIN 14	NC
PIN 15 (S)	Equalizer output - high
PIN 16	NC
PIN 17	NC
PIN 18	NC
PIN 19	NC
PIN 20 (X)	Equalizer input high
PIN 21	NC
PIN 22 (Z)	+24V DC (amplifier)

The 692EQ does not contain any transformer nor external field sensitive circuit and, therefore, can be mounted in the vicinity of power supplies, or any other source of magnetic field which would normally interfere with the operation of low level transformers. All relays on the 692EQ are by-passed by noise-suppression diodes. All relays can be easily removed for ease in maintenance.

The remote controls for the 692EQ are normally supplied mounted on the escutcheon plate unwired, unless otherwise requested.

STEREO OPERATION OF THE 692EQ

The 692EQ is the only equalizer available at this time that can be strapped for remote stereo operation. In order to affect two channels at the same time, two 692EQ boards are interconnected. All terminals on the boards are tied together with the exception of PINS 15 (S) and PINS 20 (X) which are connected separately to the separate channels.

ATTACHMENT

Schematic diagram C96278 , A96239 Remote Connections, A96328 Curve

WARRANTY & SERVICE POLICY

See standard warranty policy attached to and forming a part of this manual. To validate warranty, complete and return the warranty registration card provided. If there is any question on this, or any other FAIRCHILD professional product, contact the factory: FAIRCHILD SOUND EQUIPMENT CORPORATION, 10-40 45th Avenue, Long Island City, New York, 11101.

When returning any FAIRCHILD professional product to the factory for service, include with the shipment a brief statement indicating the reason for return to avoid unnecessary delays.

DO NOT SCALE DWG. WORK TO FIGURES.
 TOLERANCES - UNLESS OTHERWISE SPECIFIED
 DEC. DIMS. 1/16" — FRAC. DIMS. 1/32" — ANGULAR DIMS. 1/16" —
 DRILL, PUNCH, COMMERCIAL STOCK
 SIZES AND MANUFACTURERS'
 TOLERANCES ARE NOT INCLUDED.
 REMOVE ALL
 BURRS AND
 SHARP EDGES

NUMBER
C-96278
 ISSUE: 1 10-13-67
 ISSUE: 2 28-5-68
 ADD: REMOTE CONTROL UNIT
 3 - VALUE OF R1 & R3 WERE 30K. 9/1/69 S.K.
 4 - BOOST SWITCH SECTIONS 1 & 3 MODIFIED. - 4/13/71 S.K.
 5 - ADDED C14. - 6/10/71 S.K.

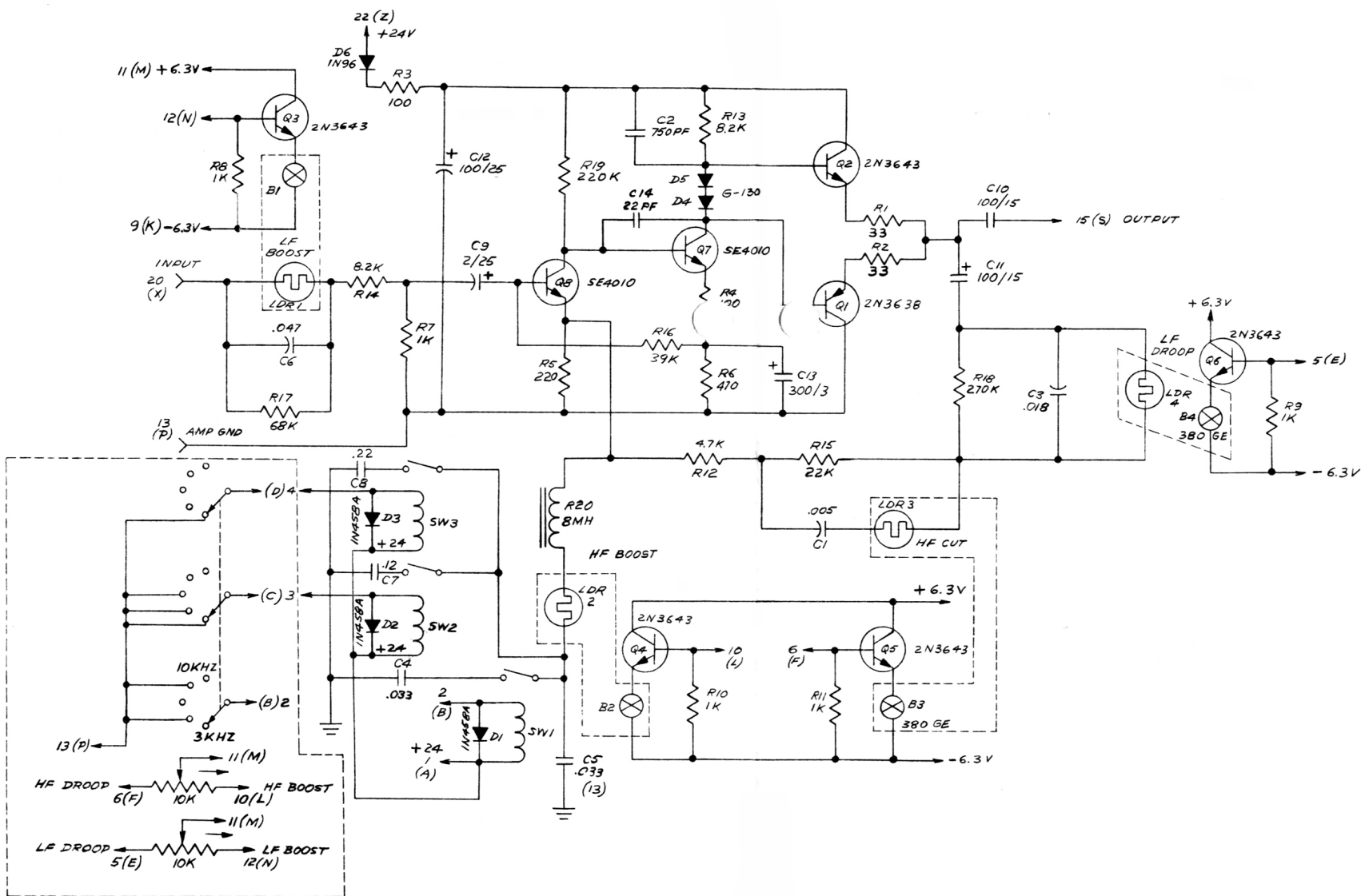

REQ	DESCRIPTION	DWG NUMBER	ITER	NEXT ASSEMBLY
MATERIAL	-	NAME		
HEAT TREATMENT	-	692EQ SCHEMATIC		
FINISH	-	FAIRCHILD RECORDING EQUIPMENT CORPORATION 10-40 45 AVE. L.I. C. I. N.Y.		
DRAWN BY	HK.	CHKD BY	DRFTE APP	SCALE NUMBER
ENG	PROJECT ENG	ENG APP	GR.	C-96278

692EQ CURVES

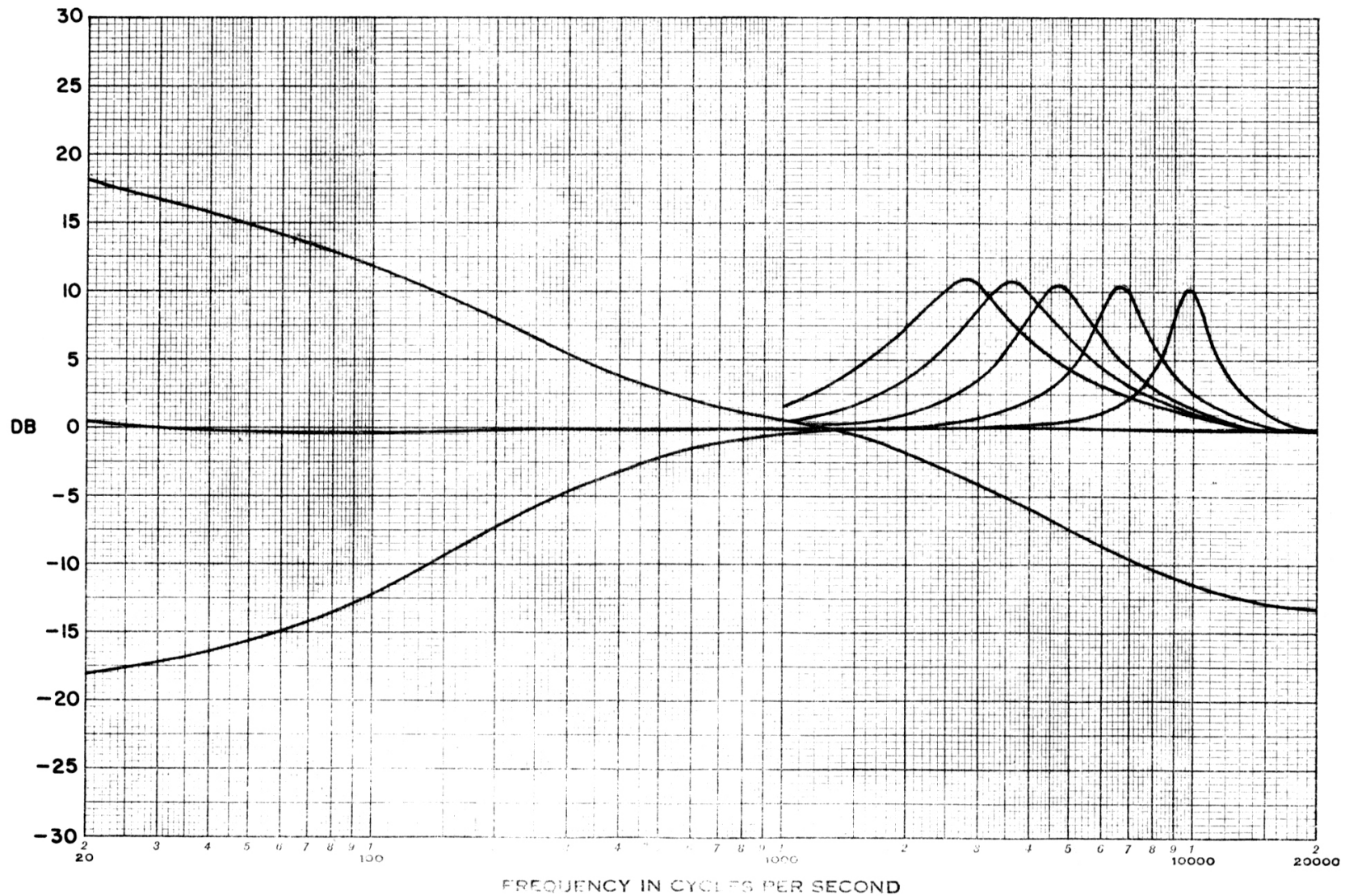

HF PEAK FREQUENCIES

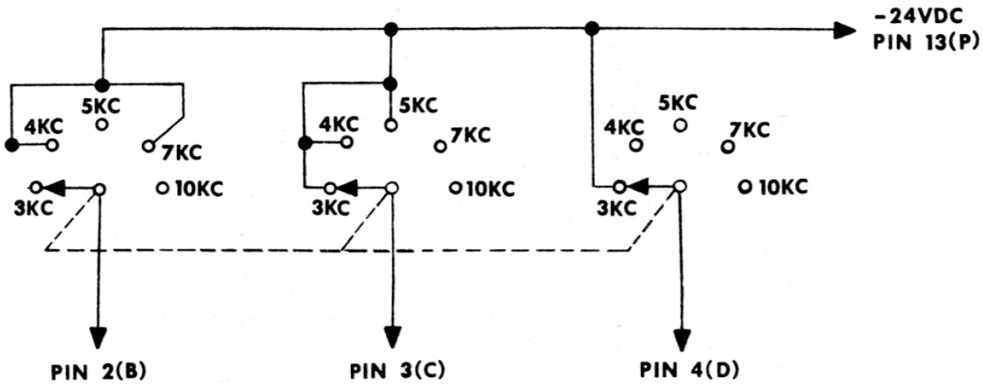

HF ACTUATOR

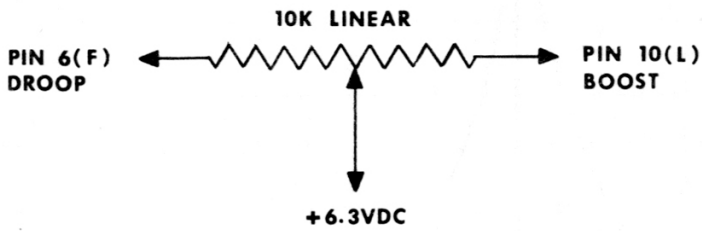

LF ACTUATOR

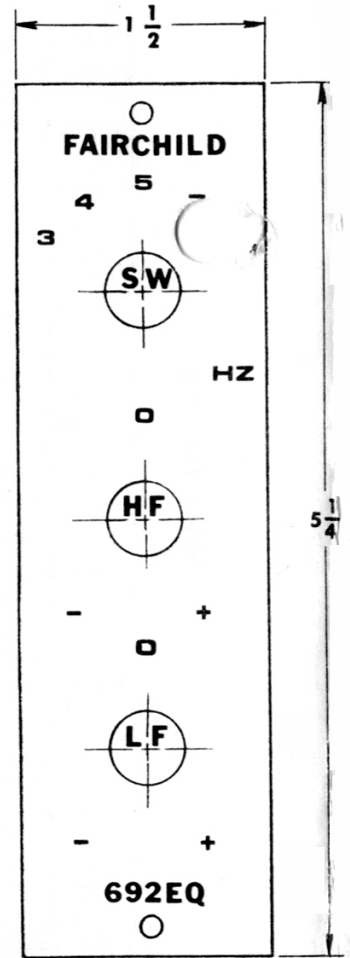
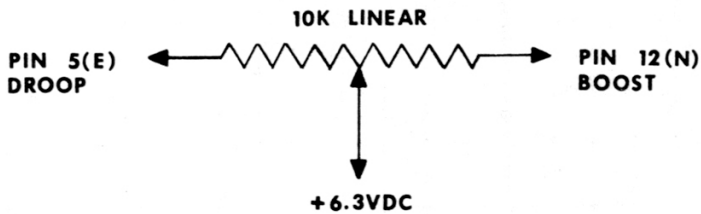

692EQ REMOTE CONTROL CONNECTIONS