

type 2010

FEATURES:

- Frequency range: 2 Hz to 200 kHz
- Linear and logarithmic frequency scales
- Voltage controlled tuning
- 6 selectable bandwidths (3,16 to 1000 Hz)
- 7 selectable averaging times (0,1 to 100 s)
- Dynamic range > 85 dB
- Distortion < 0,01%
- Built-in slave generator (BFO)
- Digital read-out of tuning and BFO frequency
- B & T programs and automatic bandwidth compensation for power spectral density measurements
- Output for exact frequency marking in connection with recorder
- Interchangeable meter scales
- Automatic range indication on meter
- DC output with 60 dB dynamic range
- Lin to log converter providing logarithmic meter deflection and DC output
- Built-in A, B, C, D filters for precision sound level measurements in accordance with IEC 651 Type 1

Heterodyne Analyzer

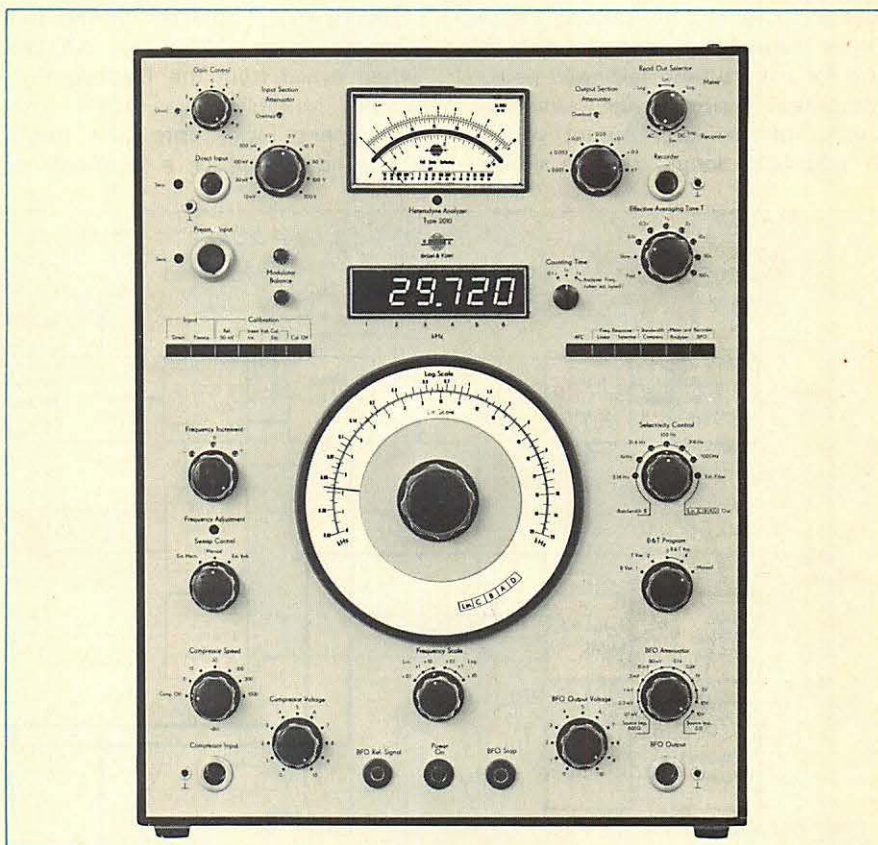

USES:

- Frequency analysis from 2 Hz to 200 kHz
- Frequency response measurements
- Power spectral density measurements
- Vibration and sound investigations
- Electroacoustical measurements
- Distortion measurements

The Heterodyne Analyzer Type 2010 is a constant bandwidth narrow band frequency analyzer covering the frequency range 2 Hz to 200 kHz in three logarithmic or linear ranges with bandwidths selectable from 3,16 to 1000 Hz. The analyzer also contains a beat frequency oscillator (BFO), the frequency of which is synchronized with the tuning frequency of the analyzer. The entire filter section can be switched out of circuit thus allowing the instrument to be used as

a voltmeter and wideband amplifier as well as allowing external filters to be connected. The tuned-in frequency can be read-off the large main frequency scale (lin and log calibration) and on a 6 digit 7-segment display. There are a number of programs in which the bandwidth and meter rectifier time constant are controlled as a function of frequency, and a bandwidth compensation has been included for power spectral density measurements.

The measured signal is rectified in a true RMS rectifier with a dynamic range of 60 dB and capability of handling signals with crest factors up to 5. The indicating meter has interchangeable scales and direct indication of measuring range. Other features included are: AFC circuit for easy tuning to signal peaks, compressor circuit for automatic control of oscillator output voltage in feed-back loops, remote control

facilities for frequency sweep, bandwidth and time constant, built-in A, B, C, D weighting networks for sound level measurements, built-in power supply for condenser microphone assemblies, output for recorders, and built-in lin-log converter giving lin or log scaled meter reading and DC output signal.

To obtain a graphic representation of the frequency analysis the 2010 can be synchronized with a Level Recorder Type 2307 or 2309, or an X-Y Recorder such as Type 2308. Both mechanical and electrical synchronization is possible with Type 2307.

The 2010 operates as an automatic tracking analyzer in the frequency range 20 Hz to 200 kHz when tuned from the Tracking Frequency Multiplier Type 1901. This instrument locks onto and tracks the fundamental or a harmonic of

practically any type of periodic waveform.

The 2010 will also operate as an automatic tracking analyzer together with the Distortion Measurement Control Unit Type 1902 for swept measurement of non-linear distortion in the range 2 Hz to 200 kHz. This instrument consists of a two-tone generator providing test signals for the measuring object, and a frequency synthesizer providing a control signal to tune the 2010. The 1902/2010 measures harmonic, difference-frequency and intermodulation distortion to DIN and IEC standards and difference-frequency and intermodulation distortion according the CCIF and SMPTE methods, respectively. Distortion components up to fifth order can be continuously tracked typically down to -80 dB. For further information on this instrument see separate data sheet.

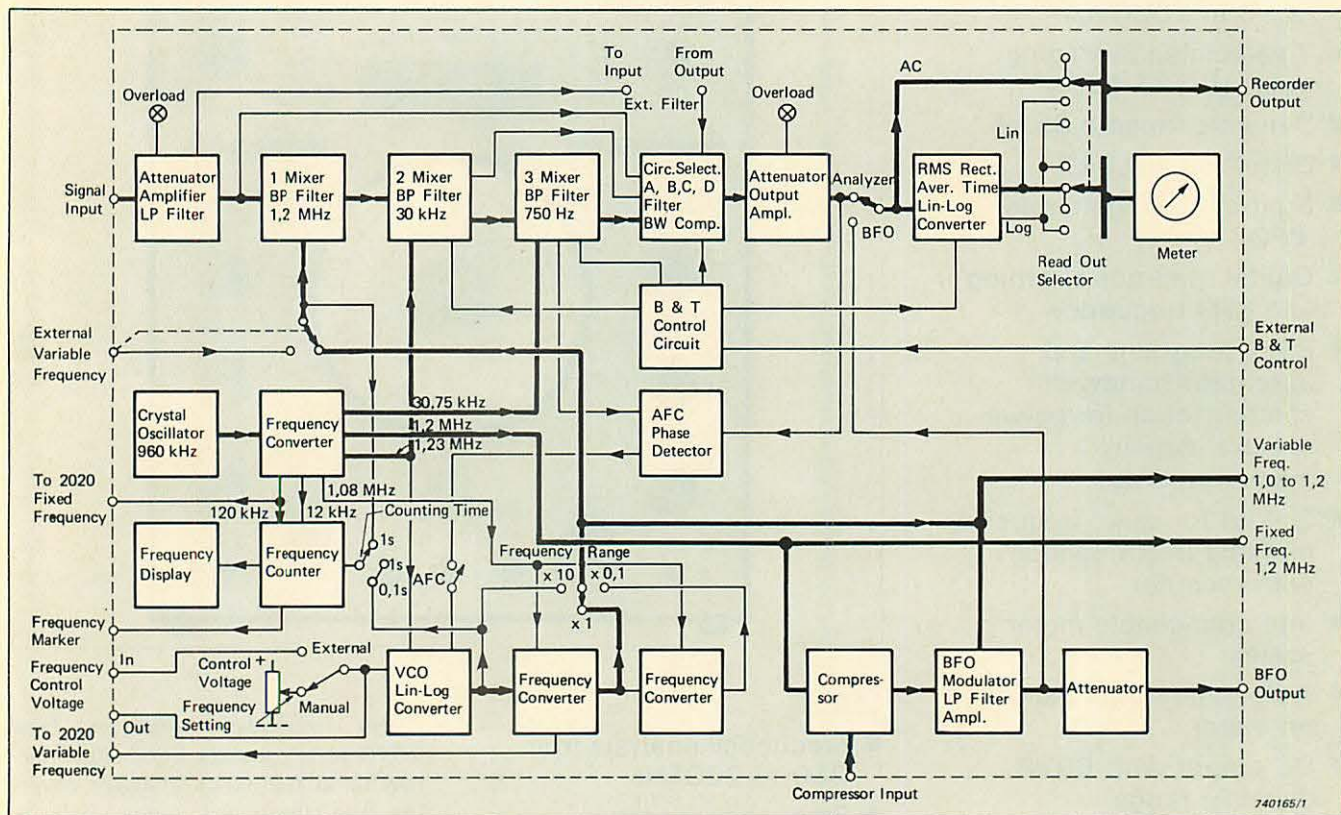

Fig. 1. Block diagram of 2010

Description

The block diagram of the 2010 shown in Fig. 1 is described in the following text.

The signal to be analyzed is fed to the first mixer stage via the input attenuator and amplifier. In the mixer

it is mixed with the signal from the voltage controlled oscillator (VCO). The frequency of this signal is adjustable in the range 1.2 MHz to 1.0 MHz in order to give a 1.2 MHz signal after mixing with the signal to be analyzed. From the first mixer

the signal is fed to the 1.2 MHz band-pass filter and to the second mixer. The frequency of the signal is here transformed to 30 kHz by mixing with a 1.23 MHz signal. The 30 kHz signal is fed to the 30 kHz band-pass filter where the 1000 Hz

and 316Hz bandwidths are obtained.

Further the signal is fed either to the selector circuit or, if narrower bandwidths are desired, to the third mixer. The frequency of the signal is transformed in this mixer to 750 Hz by mixing with a 30,75 kHz signal.

The 750Hz signal is fed to the 750Hz band-pass filter where the bandwidths in the range 100 Hz to 3,16 Hz are obtained. From the 750 Hz filter the signal is fed to the output section via a selector circuit for the A, B, C and D weighting and bandwidth compensation networks. From the output amplifier the signal is fed to the RMS rectifier, where different averaging times and a linear or logarithmic response can be selected and further to the meter where the level of the input signal is indicated.

The signal is also available at the recorder output. A selector offers the choice of an AC, linear DC or logarithmic DC signal.

The analyzer is connected to the BFO via the Voltage Controlled Oscillator. The signal from the VCO which is fed to the first mixer is also fed to the BFO where it is mixed with a 1,2 MHz signal to give a sinusoidal output signal with a frequency corresponding exactly to the tuning frequency of the analyzer. The level of this signal can be controlled automatically by means of the compressor circuit with variable compression speeds.

Input Section

The input section has a direct input (standard B & K input socket) and a B & K seven pin standard microphone input socket containing the necessary power connections for B & K microphone preamplifiers and condenser microphones. Via the input attenuator having a range of up to 90 dB attenuation the signal is fed to the low noise and low distortion input amplifier where it is amplified 40 dB. For calibration purposes the amplifier has a continuously variable gain control setting with a range of 10 dB. From the input amplifier the signal is fed to the output for external filter, the selector circuit and the first mixer. An overload indicator is connected to the amplifier.

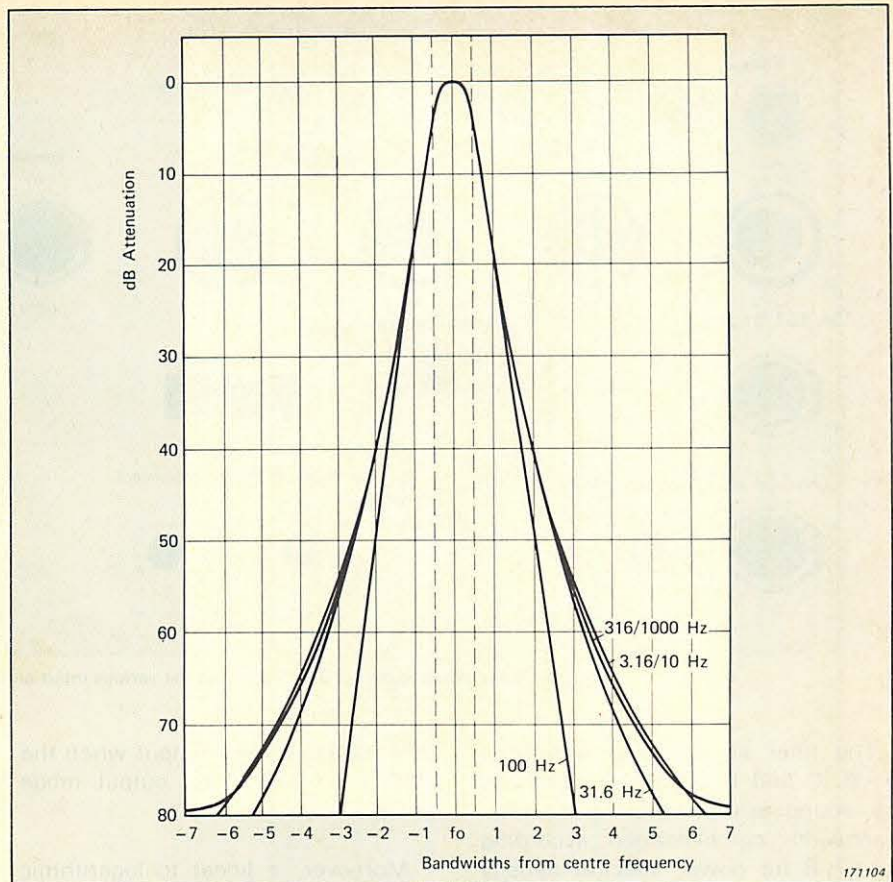

Fig.2. Typical filter characteristics of the filter section

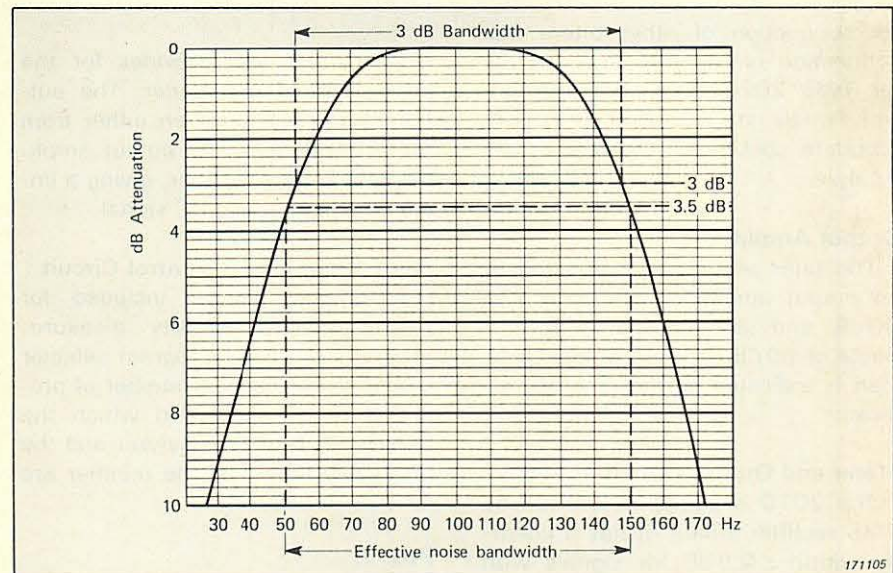

Fig.3. Top of the filter characteristic showing the effective noise bandwidth (3.5 dB) and the 3 dB bandwidth. The relation between the two is the following: 3 dB bandwidth = effective noise bandwidth \times 0,96

Filter Section

The filter section of the 2010 consists of three mixers with corresponding band-pass filters providing three intermediate frequencies of 1,2 MHz, 30 kHz and 750 Hz. The six constant bandwidths in the

range 3,16 Hz to 1000 Hz are obtained in the band-pass filter sections which are double 2 pole butterworth networks. The filters feature low distortion and high dynamic range. Fig.2 shows the filter characteristics of the networks.

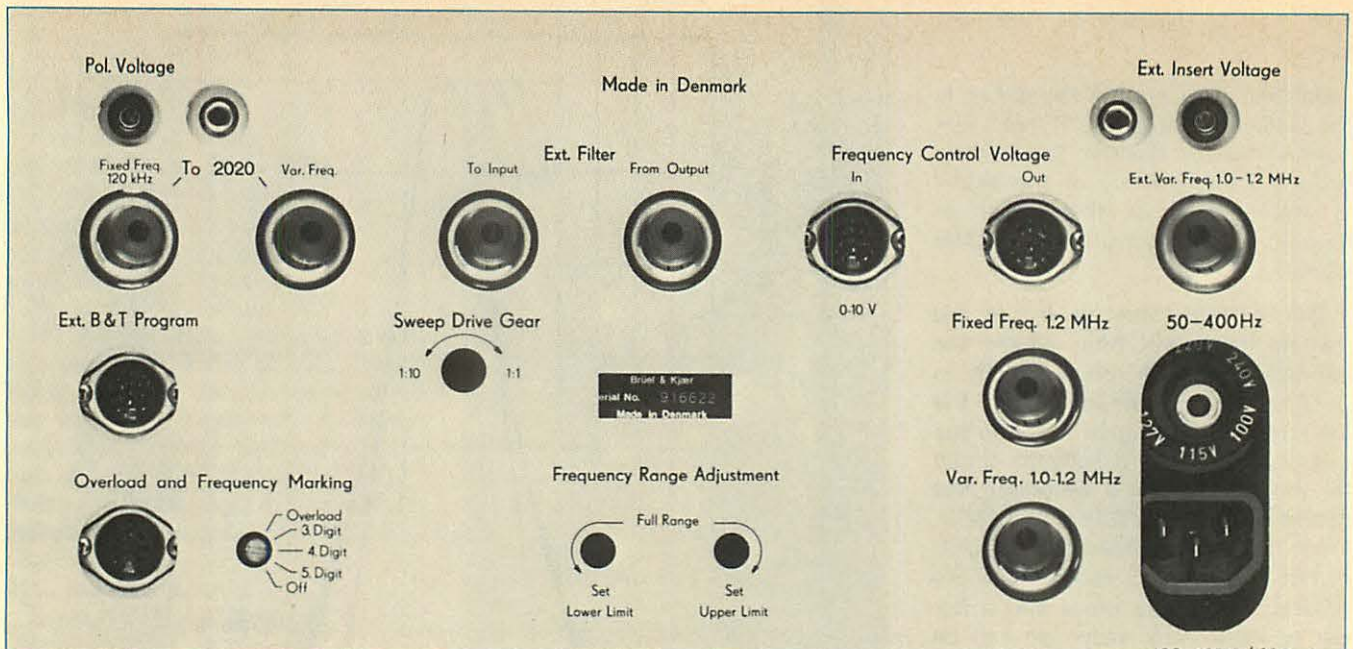

Fig.4. View of rear panel of 2010 showing the various input and output sockets

The filter section also comprises A, B, C and D weighting networks for sound level measurements and bandwidth compensation according to $1/\sqrt{B}$ for power spectral density measurements. The filter section can be by-passed to obtain a linear response, and sockets are provided for connection of other filters. For connection of Heterodyne Slave Filter Type 2020 the necessary control signals are available at the appropriate sockets at the rear of the Analyzer.

Output Amplifier

The filter section is terminated by an output amplifier with a gain of 80 dB and an attenuator with a range of 60 dB in 10 dB steps. Overload is indicated by the overload indicator.

Meter and Output Circuit

The 2010 is equipped with a true RMS rectifier circuit. It has a linearity within $\pm 0,5$ dB for signals with crest factors up to 5. The dynamic range is 50 dB (60 dB for crest-factor 1,4) and the rectifier features selectable averaging times in the range 0,1 s to 100 s. The meter has a fast and a slow mode as standardized for sound level meters. The meter can be switched between the output of the analyzer and the BFO. Connected to the BFO the meter will indicate the electromotive force of the output signal in the attenuator mode (600 Ω) and the ac-

tual voltage on the output when the BFO is in the direct output mode (5 Ω).

Moreover, a linear to logarithmic converter can be switched into circuit to give the meter a logarithmic response in addition to the linear.

The 2010 also provides for the connection of a recorder. The output signal can be taken either from the AC signal at the output amplifier or from the rectifier, giving a linear or a logarithmic DC signal.

B & T Programs — Control Circuit

A unique feature included for power spectral density measurements is the B & T program selector circuit. This allows a number of programs to be chosen in which the bandwidth B of the analyzer and the averaging time T of the rectifier are

automatically changed with the tuning frequency.

By increasing the bandwidth with increasing frequency a high scanning speed can be chosen. By simultaneously changing the time constant an equal statistical confidence over the entire frequency range is maintained.

The B & T programs can also be remotely controlled.

The following modes are available:

Pos. 1. T constant — B variable. When T is constant, the value can be selected in the range 0,1 s to 100 s with the knob "Effective Averaging Time T". The bandwidth will vary with the setting of the tuning frequency knob on the frequency scale according to the table below.

Pos. 1.

Position of bandwidth selector	Automatically selected bandwidth in Hz						
1000 Hz	3,16	10	31,6	100	316	1000	
316 Hz	3,16	3,16	10	31,6	100	316	
100 Hz	3,16	3,16	3,16	10	31,6	100	
31,6 Hz	3,16	3,16	3,16	3,16	10	31,6	
10 Hz	3,16	3,16	3,16	3,16	3,16	10	
3,16 Hz	3,16	3,16	3,16	3,16	3,16	3,16	
Switch-over Frequency Hz (x1, log scale)	63	200	630	2k	6,3k		

Switch-over frequencies x0,1, x1 and x10 according to range

Pos. 2.

Position of time constant selector	Automatically selected averaging time (s)					
0,1 s	30	10	3	1	0,3	0,1
0,3 s	100	30	10	3	1	0,3
1 s	100	100	30	10	3	1
3 s	100	100	100	30	10	3
10 s	100	100	100	100	30	10
30 s	100	100	100	100	100	30
100 s	100	100	100	100	100	100
Switch-over Frequency Hz (x1, log scale)	63	200	630	2k	6,3k	

Switch-over frequencies x0,1, x1 and x10 according to range

Pos. 3.

Position of bandwidth selector	Automatically selected bandwidth in Hz			
1000 Hz	31,6	100	316	1000
316 Hz	10	31,6	100	316
100 Hz	3,16	10	31,6	100
31,6 Hz	3,16	3,16	10	31,6
10 Hz	3,16	3,16	3,16	10
3,16 Hz	3,16	3,16	3,16	3,16
Position of averaging time selector	Automatically selected averaging time in s			
0,1 s	3	1	0,3	0,1
0,3 s	10	3	1	0,3
1 s	30	10	3	1
3 s	100	30	10	3
10 s	100	100	30	10
30 s	100	100	100	30
100 s	100	100	100	100
Switch-over frequency Hz (x1, log scale)	63	630	6,3k	

Switch-over frequencies x0,1, x1 and x10 according to range

Pos. 4.

Position of bandwidth selector	Automatically selected bandwidth in Hz		
1000 Hz	100	316	1000
316 Hz	31,6	100	316
100 Hz	10	31,6	100
31,6 Hz	3,16	10	31,6
10 Hz	3,16	3,16	10
3,16 Hz	3,16	3,16	3,16
Position of time constant selector	Automatically selected averaging time in s		
0,1 s	1	0,3	0,1
0,3 s	3	1	0,3
1 s	10	3	1
3 s	30	10	3
10 s	100	30	10
30 s	100	100	30
100 s	100	100	100
Switch-over frequency Hz (x1, log scale)	200	2k	

Switch-over frequencies x0,1, x1 and x10 according to range

Pos. 2. B constant — T variable. B is constant at the value selected with the knob "Selectivity Control" in the range 3,16Hz to 1000Hz. The averaging time will vary with the tuning frequency according to the table.

Pos. 3. B variable — T variable. B × T constant. B and T can be selected in such a way that the product B × T is kept constant according to the table.

Pos. 4. — B and T can be selected so that the product B × T is kept constant according to the table. Different switching frequencies have been chosen as compared to position 3.

Pos. 5. — B and T are constant. The values are those chosen by the setting of the corresponding knobs.

Internal Signal Section

The internal signal section provides the necessary signals at correct frequencies which are needed for the various circuits of the instrument. In order to obtain maximum frequency stability the section is based on a crystal parallel resonance type oscillator which generates a signal of 960 kHz. This signal is converted into a 1,23 MHz signal for the second mixer stage and the VCO, 1,2 MHz for the BFO, 1,08 MHz for the frequency converter of the VCO, 120 kHz for the frequency counter, 30,75 kHz for the third mixer stage and 12 kHz for the frequency counter.

Voltage Controlled Oscillator (VCO)

The VCO which makes the 2010 well suited for external control and programming supplies the variable frequency signal for the first mixer stage and for the BFO. The controlling DC voltage is supplied either from a potentiometer connected to the shaft in the centre of the main frequency scale or from an external source for remote control of the frequency sweep. The DC signal is either fed directly to the oscillator circuit giving a linear sweep or via a linear to logarithmic converter resulting in a logarithmic sweep. When a varying DC control voltage is applied there will be a delay in the frequency change of the output signal corresponding to 1,5 ms. If,

for instance, the regulation voltage changes at a rate corresponding to 100Hz/s the signal frequency will be $1,5 \times 10^{-3} \times 100 = 0,15\text{ Hz}$ "behind". The settling down time of the VCO is 30ms. In addition to these control voltages the output frequency of the VCO can also be controlled by an AFC circuit which can be switched into operation in connection with the four narrower bandwidths of the analyzer. In order to cover the necessary frequency range the output signal from the VCO, which covers the range from 1,2 MHz to 1,0 MHz (output range 0 to 200 kHz), is fed to two converters which each decrease the range by one decade. The first converter has a range of 1,2 MHz to 1,18 MHz (output range 0 to 20 kHz) and the second has a range of 1,2 MHz to 1,198 MHz (output range of 0 to 2 kHz). In this way the same relative frequency stability is obtained in all three ranges.

Frequency Counter

A counter circuit measures the frequency of the signal generated by the voltage-controlled oscillator and displays it on the built-in six di-

"Pull-in" range in Hz (Limit: 0,5 dB error in level)

Freq. range \ BW	3,16 Hz	10 Hz	31,6 Hz	100 Hz
x 0,1	10	—	—	—
x 1	10	100	100	—
x 10	10	100	1000	1000

"Pull-in" speed in Hz/s

Freq. range \ BW	3,16 Hz	10 Hz	31,6 Hz	100 Hz
x 0,1	1	—	—	—
x 1	1	20	20	—
x 10	1	20	200	400

git 7-segment display. The counting time is selected with the three-position COUNTING TIME selector in its two first positions and is either 0,1 s or 1 s. In the third position the analyzing frequency of the analyzer section is displayed when this is externally tuned. The counting time in this position is 1 s. A special output from the counter is available for control of an event marker on recorders, and a switch on the back panel gives the choice of marker pulses in the range 1 Hz to 10 kHz depending on frequency range setting.

Automatic Frequency Control (AFC)

The Analyzer is equipped with an AFC phase detector circuit controlling the Voltage Controlled Oscillator and thereby the tuning of the instrument. The AFC circuit is active in the four lower bandwidths (3,16 to 100 Hz). This circuit is intended to be used when measurement is carried out on a signal of varying frequency. In the tables above, the frequency range and the speed of "Pull-in" are given as a function of the set bandwidth and the frequency range used.

Examples of Use

Measurements on Hi-Fi Amplifiers

The Heterodyne Analyzer Type 2010 is an excellent measuring tool for performing a wide range of measurements on high fidelity amplifiers. Fig.5 shows an example of such a set-up where a Level Recorder Type 2307 is used to obtain a graphical representation of the measurements.

A frequency response measurement can be made with the switch in position "1". In position "2", simultaneous measurement of hum, noise, and cross-talk can be carried out. The recording in Fig.6 is made with the switch in position "2". The hum content is seen to be dominant at 50 Hz and 150 Hz. Outside these frequencies the noise content is noticed at the lower and middle frequencies while at higher frequencies the cross-talk becomes the most prevalent component.

Frequency Response Recording at Low Levels

Fig.7 shows the frequency re-

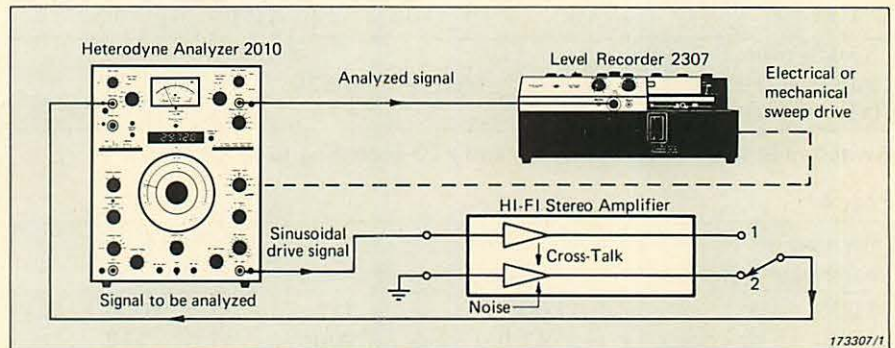

Fig.5. Example of set-up for measurements on Hi-Fi stereo amplifiers

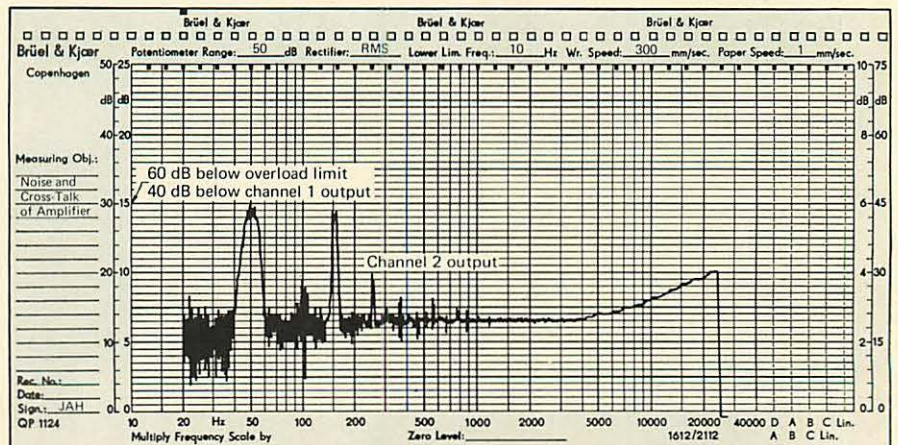

Fig.6. Simultaneous recording of hum, noise, and cross-talk

sponse of a mini shaker (4810) driven by the BFO output of the 2010 at a low vibration level.

The upper curve was recorded with the analyzer in the linear mode. It shows that the signal level is of the same magnitude as the background noise and cannot be recorded without using narrow band analysis. The lower curve shows the same signal recorded with the analyzer in the selective mode (3,16Hz bandwidth). Only the fundamental originating from the BFO is recorded, thus the influence of noise, spurious vibration and harmonic distortion is rejected.

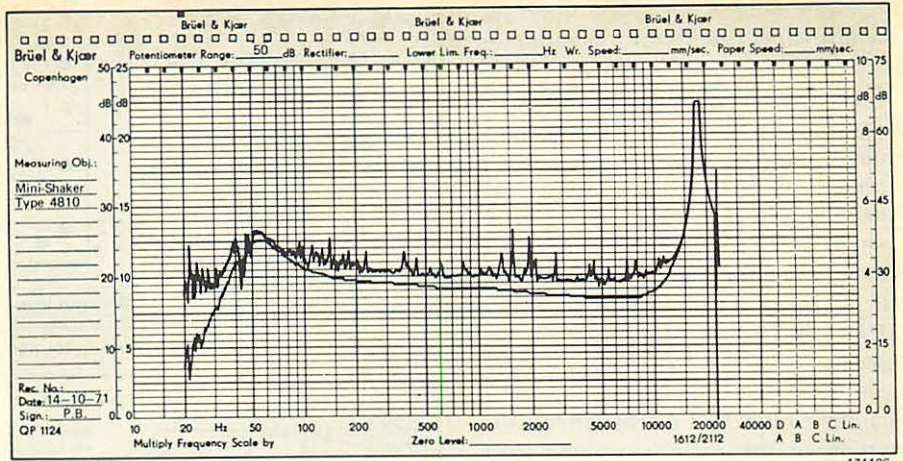

Fig. 7. Recording of frequency response of mini-shaker driven at low vibration level

Frequency Analysis of Mechanical Vibrations

The 2010 finds wide application in the field of mechanical vibration. Fig. 8 shows a set-up for analysis of mechanical vibrations.

The transducer, which is mounted on the part of the structure (an electric motor) where the vibration is to be measured, picks up the acceleration and converts it to an electrical signal which is fed to the Conditioning Amplifier 2626 for amplification. The 2626 is a preamplifier of the charge type, which means that it measures the change in charge appearing over the transducer. As the 2626 is only sensitive to charge changes the connecting cable between the transducer and the preamplifier may be of considerable length. From the preamplifier the amplified signal is fed to the input of the 2010 for analysis.

In connection with the recording in Fig. 9 a bandwidth of 10Hz and a frequency range of 20Hz to 20kHz was chosen. The Level Recorder 2307 which was connected to the 2010 by a flexible shaft supplied the drive for the frequency sweep. The range potentiometer of the recorder was a 75 dB potentiometer. The curve recorded shows that the acceleration is greatest around 40Hz with additional peaks around 100Hz and 300Hz.

In order to make a detailed investigation of the peak appearing at 300Hz the settings of the 2010 and the recorder 2307 were changed. The bandwidth was changed to 3,16Hz to get as accurate a frequency determination as possible, the frequency range was changed to the 2Hz to 2kHz range in order

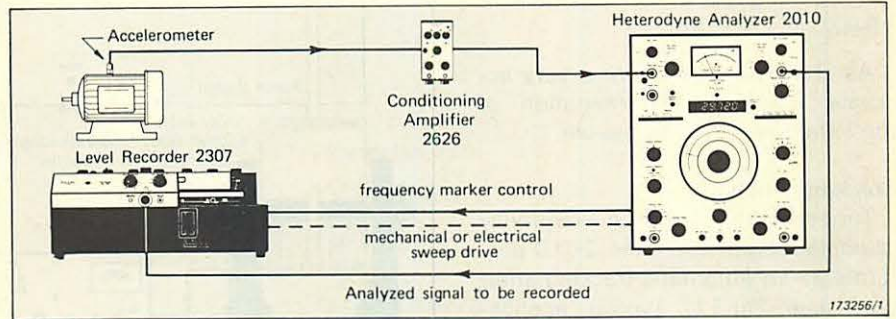

Fig. 8. Example of instrument set-up for recording vibration spectrums

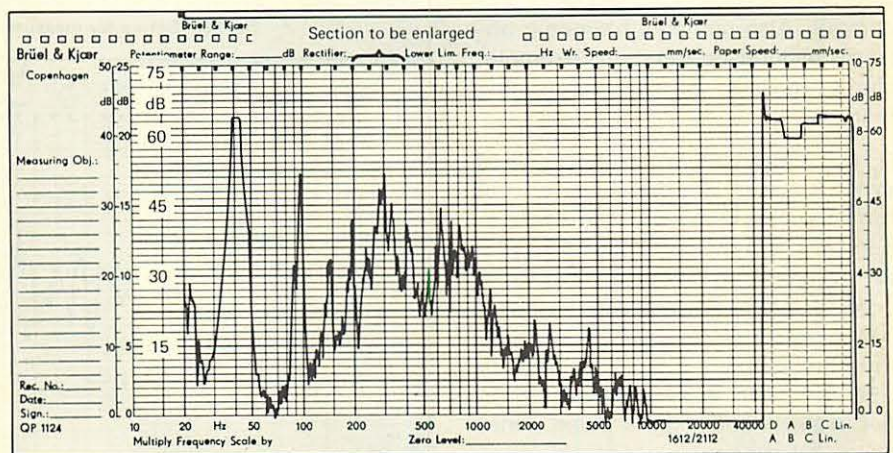

Fig. 9. Recording of frequency analysis of the vibrations of a small electric motor

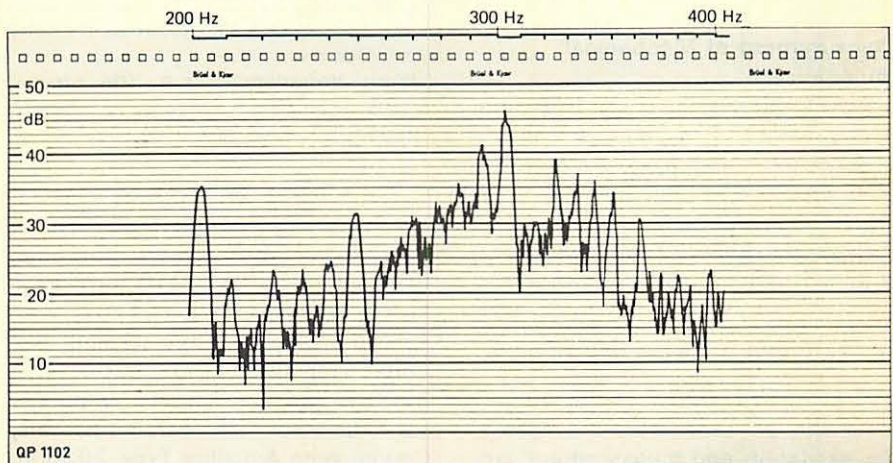

Fig. 10. Enlarged section of frequency analysis in Fig. 9. The top of the chart shows the event marker frequency calibration

to get the curve enlarged in the X-direction, and the range potentiometer of the recorder was changed to 50 dB in order to have the curve enlarged in the Y-direction. The frequency marker function was incorporated as use was in this case made of uncalibrated paper. The marker circuit, which is connected with the digital display circuitry was set to give an impulse for every 10 Hz. As can be seen from the recording in Fig.10 the marker on the recorder was activated by the marker circuit and a frequency calibration of the recording paper was thus obtained. The marker circuit gives a long pulse for multiples of 10 Hz.

As shown in the figure a very accurate frequency determination of the enlarged curve is possible.

Tracking Analysis

Tuned from a Tracking Frequency Multiplier Type 1901 the 2010 performs as an automatic tracking analyzer, see Fig.11. Typical applications are synchronous acoustic and vibration analysis of rotating machinery. Also complex harmonic analysis of loudspeakers, for example, can be made in an extremely simple manner.

The 1901 can tune the Heterodyne Analyzer to multiples of the fundamental frequency. Multiplication factors between 1 and 999 can be selected in steps of 1. The 1901 accepts periodic triggering signals between 30 mV and 300 V RMS in the frequency range 20 Hz to 200 kHz. The signal waveform is not critical, and e.g. a pulse, sine, square or triangular waveform is applicable.

Measurement of Mechanical Impedance

Fig.12 shows a set-up for the measurement of the mechanical impedance of a beam in a structure. The mechanical impedance of a structure is defined as the ratio of the exciting force F to the velocity V obtained when applying the force, i. e.:

$$\bar{Z} = \frac{F}{V} \text{ (Newtons per metre/s)}$$

As can be seen from the sketch the excitation and measurement are carried out at the same point resulting in the measurement of the

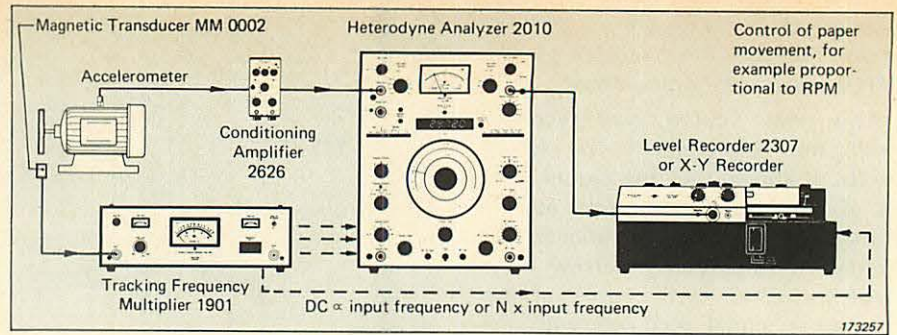

Fig. 11. Set-up for performing tracking analysis

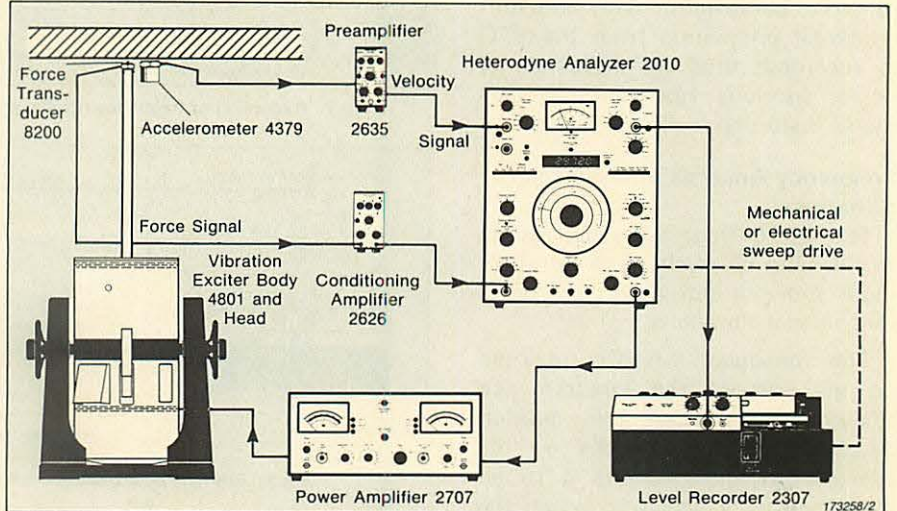

Fig. 12. Set-up for measurement of mechanical impedance

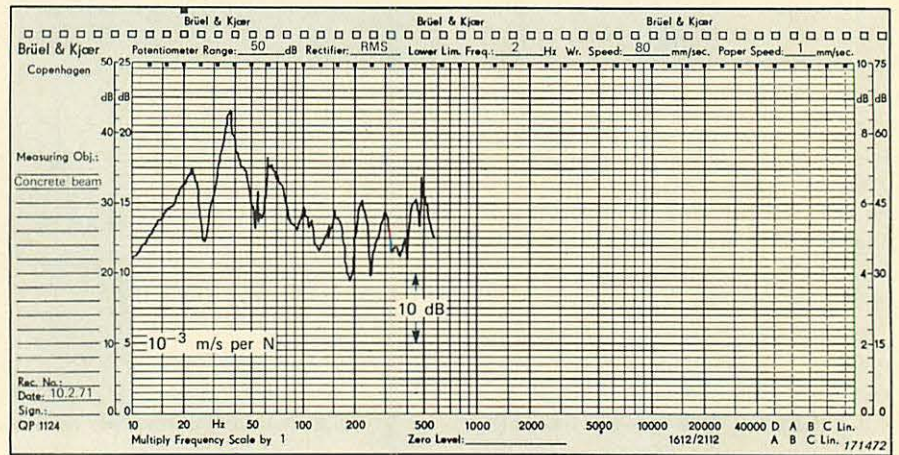

Fig. 13. Recording of mobility measured with set-up in Fig. 12

“point impedance” i.e. the structure’s ability to withstand or absorb vibrations.

The force is applied by means of an Exciter 4801 with Mode Study Head Type 4814 driven from the BFO output on the 2010 through a Power Amplifier Type 2707 and applied to the structure through the Force Transducer Type 8200. The 8200 is connected to the compressor input of the 2010 via the Conditioning Amplifier Type 2626 in order to secure constant force at the excitation point throughout the

entire frequency sweep. The resulting acceleration is measured by the Accelerometer Type 4379 and the signal is integrated in the 2635 in order to obtain the velocity signal for calculating the mechanical impedance. The velocity signal is frequency analyzed in the 2010 and recorded on the Recorder 2307. As the applied force is kept constant the recording (as can be seen from the formula) will represent the mobility of the beam at the measuring point. The mobility being the reciprocal of the mechanical impedance. The recording is shown in Fig. 13.

Frequency Analysis of Mains

The chart in Fig. 14 shows an analysis of a 50 Hz mains signal. The content of harmonics is measured up to the 23rd harmonic (1150 Hz) the level of which is seen to be 80 dB below the level of the Fundamental. The analysis was carried out using the analyzer section of the 2010 connected to a Level Recorder 2307. The 3,16 Hz bandwidth was used for the analysis.

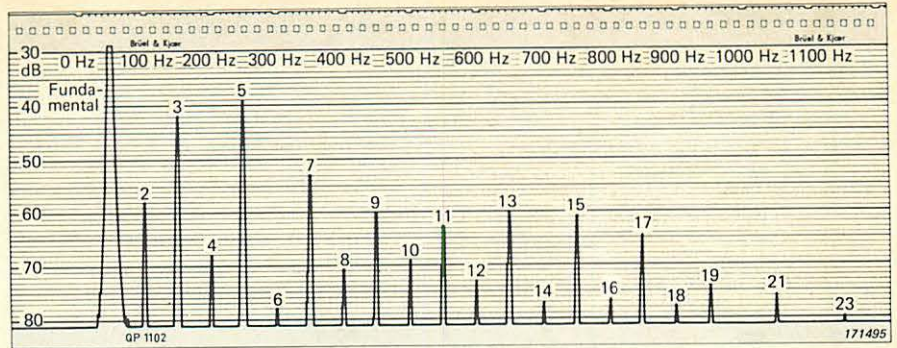

Fig. 14. Analysis of harmonics on mains

Specifications 2010

ANALYZER SECTION

Frequency Range:

2 Hz to 200 kHz in three linear and logarithmic ranges

Pos. × 0,1: 2 Hz to 2 kHz

Pos. × 1: 20 Hz to 20 kHz

Pos. × 10: 200 Hz to 200 kHz

Frequency Response:

Linear Mode:

± 0,2 dB (10 Hz to 50 kHz)

± 0,5 dB (2 Hz to 200 kHz)

Selective Mode:

1: Six constant bandwidth band-pass filters

2: A, B, C and D weighting networks

3: External filter

Sensitivity:

10 μV to 300 V for full deflection in 10 dB steps

Input Section:

Input Impedance: 1 MΩ || 80 pF (direct input)

Output Impedance (to ext. filter): < 25 Ω

Max. Output Voltage: 5 V PEAK

Input Amplifier Gain: 40 dB

Gain Control: 0 dB (cal) to -10 dB

Input Attenuator range: 90 dB in 10 dB steps

Accuracy of attenuator: ± 0,1 dB relative to "0,1 V" at 1 kHz

Distortion: < 0,01% (20 Hz to 50 kHz, output voltage ≤ 1 V)

< 0,03% (20 Hz to 100 kHz, output voltage ≤ 1 V)

Noise:

With max. amplification and input short circuited

Centre frequency ≥ 2 × bandwidth

Bandwidths 3,16 to 100 Hz: < 0,6 μV

Bandwidths 316 to 1000 Hz: < 1,2 μV

A, B and C weighting: < 2 μV

D weighting: < 5 μV

Linear (2 Hz to 200 kHz): < 7 μV

Constant Bandwidth Filters:

Type: Double 2 pole butterworth

3,5 dB Bandwidths: (Effective noise bandwidths) 3,16 Hz, 10 Hz, 31,6 Hz, 100 Hz, 316 and 1000 Hz

3 dB bandwidth = effective noise bandwidth × 0,96

Accuracy of bandwidths: ± 5%

Shape factor of filter characteristic:

$\frac{BW_{60\text{ dB}}}{BW_{3\text{ dB}}} \leq 7$

Dynamic Range:

> 85 dB (in bandwidths 3,16 to 100 Hz)

> 75 dB (in bandwidths 316 and 1000 Hz)

Distortion (Input section and filter):

< 0,01% (60 Hz to 50 kHz)

< 0,03% (20 Hz to 100 kHz)

Bandwidth Compensation:

Automatic $1/\sqrt{B}$ compensation

Weighting Networks:

Curves A, B, C and D in accordance with IEC standard 179

Output Section:

Input Impedance (from ext. filter): 146 kΩ

Output Amplifier Gain: 80 dB

Output Attenuator Range: 60 dB in 10 dB steps

Accuracy of steps ± 0,1 dB relative to the ×1 position at 1 kHz

Meter:

Full Scale deflection: 10 V RMS at Recorder Output (linear)

31,6 V RMS at Recorder Output (logarithmic)

Scale range (log mode): 50 dB

Averaging times: "Fast" and "Slow" according to IEC 651 (Type 1) and 0,1; 0,3; 1; 3; 10; 30; 100 s

Scales: Interchangeable, for direct reading of voltage, dB, dB Lin/Log, sound level, acceleration, power spectral density, absorption coefficient, dB/dBm, using different transducers and accessories. Scales can be custom made to order

Recorder Output:

AC:

Output voltage: 10 V RMS at full deflection (linear meter mode)

Max. voltage: 50 V Peak

Output impedance: 50 Ω in series with 32 μF

Load impedance: ≥ 12 kΩ

Frequency of Output Signal: 30 kHz (in 316 Hz and 1000 Hz bandwidth) — 750 Hz (3,16 — 100 Hz bandwidth) — signal frequency in linear and A, B, C and D filter mode

DC Linear mode:

Output voltage: 4,5 V at full deflection ~ 10 V RMS AC

Max. voltage: 15 V

Dynamic range: -50 dB to +10 dB re full meter deflection

Crest factor capability: Up to 5 at full deflection decreasing to 1,4 at +10 dB

Accuracy of RMS indication: ± 0,5 dB for crest factors up to 5

Linearity of RMS indication: ± 0,3 dB in the range -40 dB to 0 dB and ± 0,5 dB over the entire range

Output impedance: < 10 Ω

Load impedance: ≥ 5 kΩ

Averaging times: 0,1; 0,3; 1; 3; 10; 30; 100 s

DC Logarithmic mode:

Output voltage: 4,5 V at full deflection ~ 31,6 V AC. Lin/log conversion ratio 0,09 V (DC)/dB (AC)

Dynamic range: -50 dB to 0 dB re 4,5 V

Crest factor capability: Up to 5 at -10 dB decreasing to 1,4 at 0 dB

Accuracy of RMS indication: ± 0,5 dB for crest factors up to 5

Linearity: ± 0,5 dB

Output impedance: < 10 Ω

Load impedance: ≥ 5 kΩ

Averaging times: As for linear mode

AFC:

Active in the Bandwidths 3,16 Hz to 100 Hz

"PULL IN" Range: 10 Hz to 1 kHz depending on bandwidth and frequency range. See table inside leaflet

Overload Indicators:

Overload indicators for input and output amplifiers

Lamps light for overload pulse longer than 0,2 ms, remain lit for min. 0,5 s

Relay output of overload function

Reference Voltage (built-in oscillator):

50 mV RMS at 1000 Hz sinusoidal

Amplitude stability: ± 0,2 dB

Frequency stability: ± 2%

Distortion: < 2%

B & T Program:

Automatic switching of bandwidth B and averaging time T (see text). Input socket for external control

BFO SECTION		
<p>Frequency Range: 2 Hz to 200 kHz (Identical to analyzer)</p> <p>Accuracy of Output Frequency: see frequency read-out section</p> <p>Amplifier Linearity: ± 0,2 dB (2 Hz to 200 kHz)</p> <p>Output Voltage: Attenuator Output: 100 μV to 10 V variable continuously and in 10 dB steps. Output Impedance is 600 Ω in all attenuator positions. Accuracy of steps ± 0,1 dB relative to 10 V position Direct Output: 0 to 10 V continuously ad-</p>	<p>justable. Output impedance 5 Ω Max. Output Power: 0,75 W at 140 Ω load</p> <p>Distortion: < 0,015% (20 Hz to 50 kHz) < 0,03% (20 Hz to 100 kHz)</p> <p>Noise: < -70 dB</p> <p>Hum: < -80 dB</p> <p>Compressor Circuit: Range of Regulation: 60 dB (compres-</p>	<p>sor voltage within 1 dB) Frequency Response: ± 0,3 dB (2 Hz to 200 kHz) Compressor Input Voltage: min. 0,5 V Compressor Speed: 3, 10, 30, 100, 300, 1000 dB/s</p> <p>Reference Voltage: When the knob "BFO REF. Signal" is pressed the frequency of the BFO output signal is changed to 100 Hz in the x 0,1 range, to 1 kHz in the x 1 range and to 10 kHz in the x 10 range. The output voltage having the value set by the output attenuator and output voltage knobs</p>

FREQUENCY READ-OUT																																		
<p>Frequency Counter: Six Digits Accuracy: ± 1 on last digit + 20 ppm of tuning frequency Counting Time: 0,1 s (five digits) and 1 s</p> <p>Frequency Scale: Lin, and Log scales</p> <p>External Frequency Control: Sensitivity of VCO with external voltage: Full scale sweep: 0 to 10 V DC Lin scale × 0,1: 0,2 kHz/V Lin scale × 1: 2 kHz/V Lin scale × 10: 20 kHz/V Log scale: 0,3 decade/V corresponding to 1 octave/V</p>	<p>Sensitivity of VCO with external mechanical drive: Full scale sweep: 30 rotations with sweep drive gear in 1:1 300 rotations with sweep drive gear in 1:10</p> <p>Frequency Accuracy: 0,3% of scale range (Lin scale) 3% of reading + 25 ppm of scale range (log scale)</p> <p>Linearity of Voltage to Frequency conversion: 0,03% of scale range (Lin scale)</p> <p>Frequency Increment Range: Linear scale: ± 1% of scale range Logarithmic: ± 7% of scale reading or 0,1 octave</p>	<p>Frequency Marker: Output for event marker on recorder for exact chart calibration</p> <p>Frequency Stability: Measured over 8 hours after 1 hour warm-up</p> <table border="1" style="width: 100%; border-collapse: collapse; text-align: center;"> <thead> <tr> <th colspan="4">Low end of scale</th> </tr> <tr> <th>Scale</th> <th>2 Hz</th> <th>20 Hz</th> <th>200 Hz</th> </tr> </thead> <tbody> <tr> <td>Lin</td> <td>0,15 Hz</td> <td>1,5 Hz</td> <td>15 Hz</td> </tr> <tr> <td>Log</td> <td>0,15 Hz</td> <td>1,5 Hz</td> <td>15 Hz</td> </tr> </tbody> <thead> <tr> <th colspan="4">High end of scale</th> </tr> <tr> <th>Scale</th> <th>2 kHz</th> <th>20 kHz</th> <th>200 kHz</th> </tr> </thead> <tbody> <tr> <td>Lin</td> <td>1 Hz</td> <td>10 Hz</td> <td>100 Hz</td> </tr> <tr> <td>Log</td> <td>4 Hz</td> <td>40 Hz</td> <td>400 Hz</td> </tr> </tbody> </table>	Low end of scale				Scale	2 Hz	20 Hz	200 Hz	Lin	0,15 Hz	1,5 Hz	15 Hz	Log	0,15 Hz	1,5 Hz	15 Hz	High end of scale				Scale	2 kHz	20 kHz	200 kHz	Lin	1 Hz	10 Hz	100 Hz	Log	4 Hz	40 Hz	400 Hz
Low end of scale																																		
Scale	2 Hz	20 Hz	200 Hz																															
Lin	0,15 Hz	1,5 Hz	15 Hz																															
Log	0,15 Hz	1,5 Hz	15 Hz																															
High end of scale																																		
Scale	2 kHz	20 kHz	200 kHz																															
Lin	1 Hz	10 Hz	100 Hz																															
Log	4 Hz	40 Hz	400 Hz																															

GENERAL		
<p>Operating Temperature: 10° to 40°C (50° to 104°F)</p> <p>Max. Humidity: 90% RH (non condensing) at 30°C</p> <p>Electromagnetic Compatibility: Complies with class B computing device requirements of American FCC (Federal Communication Commission) Rules</p> <p>Power Supply: 100, 115, 127, 220, 240 V (± 10%) 50 to 400 Hz, 50 VA. Complies with IEC 348 safety class I</p> <p>Cabinet: Supplied as model A (light-weight metal cabinet), B (model A in mahogany cabinet) or C (as A but with flanges for standard 19" racks)</p> <p>Dimensions (A model): Height: 480 mm (19 in)</p>	<p>Width: 380 mm (15 in) Depth: 200 mm (8 in)</p> <p>Weight: 21 kg (46,7 lbs)</p> <p>Accessories Included: 2 coaxial cables AO 0013 1 control cable AQ 0034 2 coaxial plugs JP 0101 1 7-pin plug JP 0703 1 8-pin plug JP 0802 1 voltage and dB scale (fitted on delivery) SA 0051 1 dB scale SA 0052 1 log scale SA 0053 1 P.S.D. scale SA 0055 1 scale for 1" microphone SA 0056 1 scale for 1/2" microphone SA 0057 1 scale for acceleration measurement SA 0058 (6 to 17 mV/g) 1 Log/Lin dB scale SA 0059</p>	<p>1 uncalibrated scale (0 to 100) SA 0087 1 flexible shaft UB 0041 1 power cable AN 0010 1 630 mA fuse VF 0032 1 315 mA fuse VF 0042</p> <p>Additional Scales Available: SA 0054: Absorption Coefficient scale SA 0060: 0,8 to 2,6 mV/Pa microphone scale SA 0083: 0,28 to 1,6 mV/Pa microphone scale SA 0084: dB/dBm scale SA 0142: 1,7 to 6 mV/g accelerometer scale SA 0143: 17 to 60 mV/g accelerometer scale SA 0144: 60 to 170 mV/g accelerometer scale SA 0198: Sound Measurement with Hydrophone Type 8101 Scales can be custom made to order</p>