

# BEYER DYNAMIC

## AUDIO INPUT TRANSFORMERS



# EUGEN BEYER

ELEKTROTECHNISCHE FABRIK · D 71 HEILBRONN · THERESIENSTR. 8 · P.O. BOX 1320 · TEL. (07131) 82348 · TELEX 0728771

# INTRODUCTION

BEYER DYNAMIC audio input transformers are made according to a special process which allows manufacture of both miniature and sub-miniature size transformers of very high quality. Their unique properties make them amenable to a great variety of applications. You will therefore find BEYER DYNAMIC transformers in amplifiers, studio mixers, consoles and in other audio equipment of virtually every renowned manufacturer of quality audio components. BEYER DYNAMIC transformers are specified when the application places high demands on frequency response, absence of distortion, suppression of RF-interference and hum rejection.

Due to their small size and special configuration, these audio transformers are only to be used for low level signals. A DC-load on the transformers should always be avoided.

## Numbering system

The type numbers have been devised to permit complete description of all the basic data such as mounting version, wiring information and turns ratio. The type number (BV number) consists of three groups of three numbers: for example TR/BV 351 101 001

First digit: size of transformer

- 3 studio grade transformer
- 4 headphone matching transformer
- 7 sub-miniature transformer

Second and third digit: mounting version

- 310 Dual in-line PC board mounting, 8 pins, spacing 2,5 mm (0.1") (plug-in or solder mounting)
- 341 moulded plug-in transformer in metal housing for interconnection in a microphone line (with a female connector at one end and a male connector at the other end)
- 345 cable transformer moulded into a plastic housing; both ends with a 0.2 m cable.
- 347 cable transformer moulded into a plastic housing; female connector on the input side; output side with 0.2 m cable
- 351 chassis single threaded stud mount
- 352 solder lug mounting
- 353 single threaded stud mounting with shielded leads
- 360 plug-in mounting for miniature tube socket
- 370 7-pin PC board mounting (plug-in or solder mounting)
- 380 8-pin PC board mounting (plug-in or solder mounting)
- 390 9-pin PC board mounting (plug-in or solder mounting)
- 741 same as 341, but sub-miniature transformer
- 745 same as 345, but sub-miniature transformer
- 747 same as 347, but sub-miniature transformer
- 752 with two solder lugs, leads brought out two ends
- 755 with one solder lug, leads brought out two ends
- 756 with one solder lug, leads brought out one end only

Fourth digit: primary winding configurations

- 0 single primary
- 1 center tapped primary
- 2 split bifilary wound primaries
- 3 split bifilary wound primaries, connected in the middle (single winding brought out)

Fifth and sixth digit: turns ratio

01	= 1:1
03	= 1:3
05	= 1:5
07	= 1:7
10	= 1:10
15	= 1:15
20	= 1:20
30	= 1:30
etc.	
00	= special turns ratio (see individual data sheet for corresponding transformer)

Seventh, eighth and ninth digit: these digits are the subsequential type number of the transformer. This number is based on the specific electrical qualities of the corresponding transformer. The running number remains unchanged for a unit even though its mechanical form, whether stud mount, PC mount or cable transformer, changes or its primary winding is split or tapped.

TR/BV 3...001 — 020	standard transformer	$R_{gen} = 200$ ohms
TR/BV 3...021 — 030	special transformer	$R_{gen} = 200$ ohms
TR/BV 3...031 — 050	standard transformer	$R_{gen} = 600$ ohms
TR/BV 3...051 — 060	special transformer	$R_{gen} = 600$ ohms
TR/BV 3...061 — 060	standard transformer	$R_{gen} = 1200$ ohms
TR/BV 3...081 — 100	special transformer	
TR/BV 3...101 — 120	special transformer	turns ratio $\leq 1$
TR/BV 7...251 — 275	standard transformer	$R_{gen} = 200$ ohms
TR/BV 7...276 — 299	standard transformer	$R_{gen} = 500$ ohms

With moulded cable and plug-in transformers, the letters at the end of the BV number indicate what types of connectors, male or female, and how these are connected:

First letter: input — all connectors female

F	cable with tinned ends (2-conductor shielded)
N	low impedance balanced 3-pole DIN standard connector with 1+3 modulation, 2 ground
L	low impedance unbalanced 3-pole DIN standard connector, 2+1 modulation, ground to shell (may be connected to 2)
M or H	medium or high impedance unbalanced 3-pole DIN standard connector, 2+1 modulation, ground to shell (may be connected to 2)
N (T)	large Tuchel connector or equivalent (only applies to BV 345...)
C	Cannon / Switchcraft or equivalent female (only applies to BV 345...)
Ci	Cinch phono plug (female)

Second letter: output — all connectors male

F	cable with tinned ends (2-conductor shielded)
N	low impedance balanced 3-pole DIN standard connector with 1+3 modulation, 2 ground
L	low impedance unbalanced 3-pole DIN standard connector, 2+1 modulation, ground to shell (may be connected to 2)
M or H	medium or high impedance unbalanced 3-pole DIN standard connector, 2+1 modulation, ground to shell (may be connected to 2)
C	cinch phono plug (male)
Ci	Cannon / Switchcraft or equivalent male
K	phone jack plug (standard 6.35 mm (1/4") diameter)

# STANDARD PROGRAM

Beyer DYNAMIC offers a standard program with different basic transformer types ranging in step-up ratio from 1:1 to 1:30. Each basic type is available in a wide range of electrical and mechanical variations so that individual requirements may be met easily. In spite of this, we continue to wind special transformers provided they are bought in quantity and do not duplicate one of the models from the standard series. The standard program considers three different generator impedances: 200 Ω, 600 Ω, 1200 Ω so that virtually all common matching values found in studio technology can be met.

The following table shows all the important data of the standard transformer program. Only the last 5 digits of the part number are shown. This means that according to what we explained earlier under the reference „numbering system“, the mounting as well as the winding configuration (digits 2 to 4 of the BV number) may be freely chosen.

TR/BV 3 . . . .	$R_{gen} = 200 \Omega$							$R_{gen} = 600 \Omega$							$R_{gen} = 1200 \Omega$			
a) frequency response at $R_{gen}$ relative to 1 kHz (open secondary)	30 — 15 000 Hz $\pm$ 1 dB																	
b) maximum input level at THD $\leq$ 1 % ( $f \geq$ 30 Hz)	300 mV																	
c) primary open circuit inductance	typ. 6 H at 50 Hz							typ. 16 H at 50 Hz							typ. 30 H at 50 Hz			
d) primary open circuit impedance	typ. 1.885 KΩ at 50 Hz							typ. 5 KΩ at 50 Hz							typ. 10 KΩ at 50 Hz			
e) turns ratio	1:1	1:3	1:5	1:7	1:10	1:15	1:20	1:1	1:2	1:3	1:5	1:7	1:10	1:1	1:2	1:3	1:4	
f) transformed impedance	200 Ω	2kΩ	5kΩ	10kΩ	20kΩ	45kΩ	80kΩ	600 Ω	2.4kΩ	6kΩ	15kΩ	30kΩ	60kΩ	1.2kΩ	5kΩ	12kΩ	30kΩ	
g) primary dc resistance	50 Ω	50 Ω	50 Ω	50 Ω	85 Ω	85 Ω	115 Ω	140 Ω	140 Ω	140 Ω	140 Ω	190 Ω	190 Ω	310 Ω	310 Ω	310 Ω	475 Ω	
h) secondary dc resistance	75 Ω	580 Ω	1.45kΩ	3.45kΩ	4.75kΩ	10.4kΩ	13.5kΩ	190 Ω	575 Ω	1.45kΩ	3.9kΩ	7.05kΩ	11kΩ	430 Ω	1.4kΩ	3.75kΩ	8.45kΩ	
i) code number *	01001	03002	05003	07004	10005	15006	20007	01031	02032	03033	05034	07035	10036	01061	02062	03063	05064	
* code number is identical with last 5 digits of the BV number																		

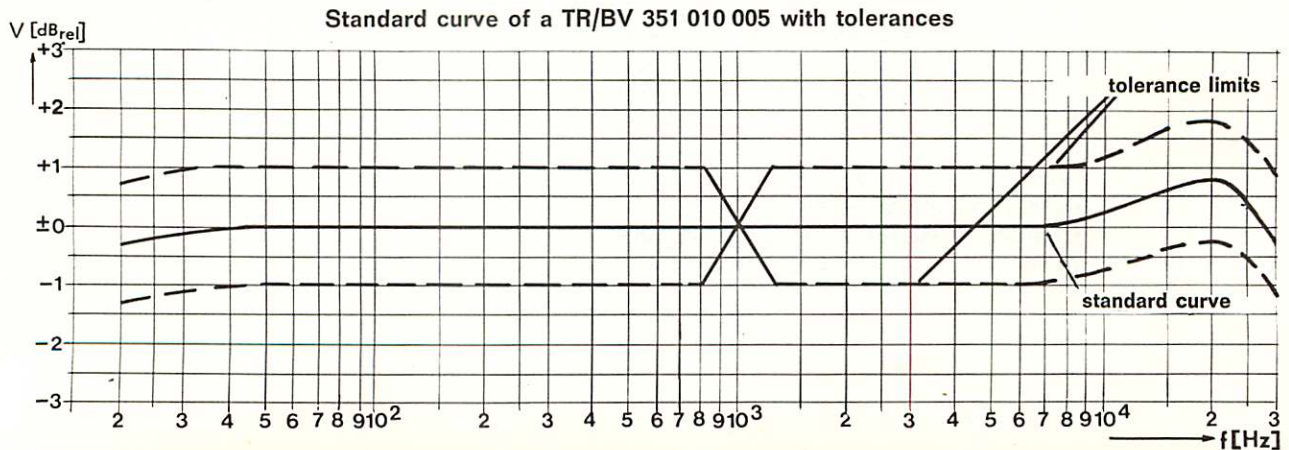

The following table shows the electrical data for the sub-miniature transformers.

TR/BV 7 . . . .	$R_{gen} = 200 \Omega$					$R_{gen} = 500 \Omega$			
a) frequency response at $R_{gen}$ relative to 1 kHz (open secondary)	50 . . . . 15000 Hz $-3/\pm 2$ dB					50 . . . . 15000 Hz $-3/\pm 2$ dB			
b) maximum input level at THD $\leq 1\%$ ( $f \geq 50$ Hz)	typ. 30 mV (typ. 100 mV at $f \geq 100$ Hz)					typ. 30 mV (typ. 100 mV at $f \geq 100$ Hz)			
c) primary open circuit inductance 50 Hz	typ. 0.6 H at $f=100$ Hz	typ. 1.6 H at $f = 50$ Hz					typ. 3.8 H at $f = 50$ Hz		
d) primary open circuit impedance 50 Hz	typ. 380 $\Omega$ at $f=100$ Hz	typ. 500 $\Omega$ at $f = 50$ Hz					typ. 1200 $\Omega$ at $f = 50$ Hz		
e) turns ratio	1:15	1:1	1:5	1:7.07	1:15.8	1:3.16	1:4.47	1:10	
f) transformed impedance	45 k $\Omega$	200 $\Omega$	5000 $\Omega$	10000 $\Omega$	50 k $\Omega$	5 k $\Omega$	10 k $\Omega$	50 k $\Omega$	
g) primary dc resistance	70 $\Omega$	45 $\Omega$	85 $\Omega$	130 $\Omega$	90 $\Omega$	140 $\Omega$	130 $\Omega$	225 $\Omega$	
h) secondary dc resistance	4.1 k $\Omega$	75 $\Omega$	970 $\Omega$	1.39 k $\Omega$	7.5 k $\Omega$	960 $\Omega$	1.4 k $\Omega$	7.85 k $\Omega$	
code number *	. . . 257	. . . 258	. . . 252	. . . 253	. . . 255	. . . 276	. . . 277	. . . 278	
* code number is identical with last 3 digits of the BV number									

Standard curve of a TR/BV 752 005 252 with tolerances

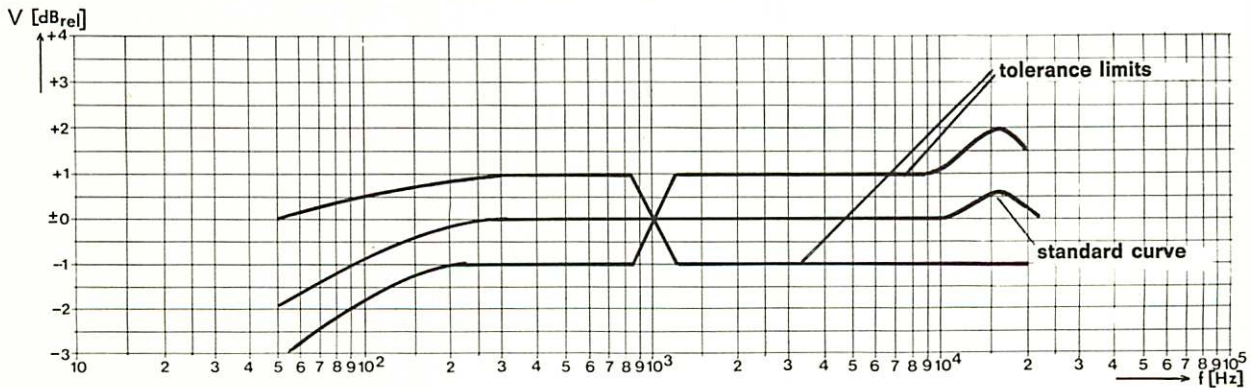

TR/BV 752 005 252 (1:5)

$R_g = 200 \Omega$

$R_L = 500 \text{ k}\Omega \parallel 200 \text{ pF}$  [ $\cong$  voltmeter + measuring cable]

$R_g =$  generator impedance

$R_L =$  Load impedance

The electrical values shown in the tables are considered typical data. These will vary when the matching values on which we based our measurements are not respected. In order to give our customers the possibility to estimate expected changes, we demonstrate these changes of the frequency response of transformer TR/BV 351 010 005 (turns ration 1:10) in case of different matching values in the following illustration curves.

The high frequency response will be strongly influenced by the choice of the load impedance and the terminal capacity (for control measurements please check on input capacitance of the voltmeter used and of the measuring cable).

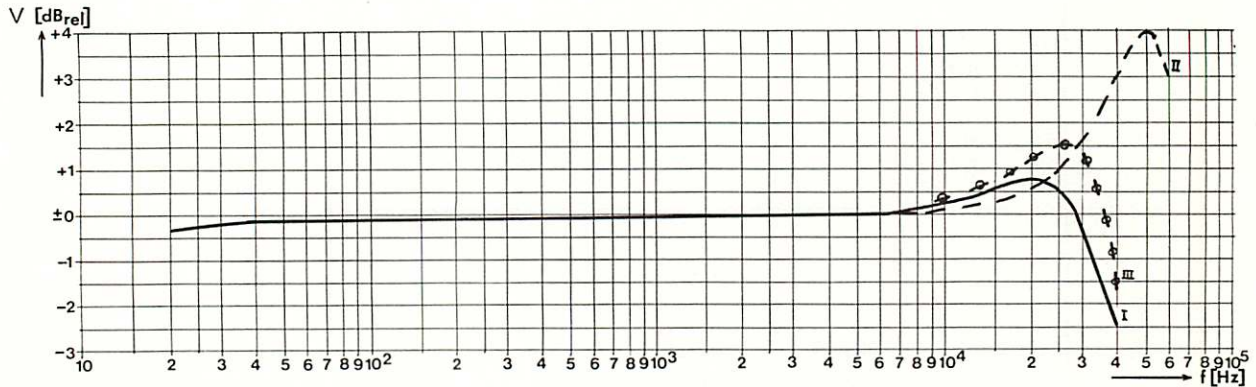

**TR/BV 351 010 005**

- Measurement with voltmeter
- I:  $R_G = 200 \Omega$   
 $R_L = 1 M\Omega \parallel 100 \text{ pF}$
  - II:  $R_G = 200 \Omega$   
 $R_L = 1 M\Omega \parallel 0 \text{ pF}$
  - III:  $R_G = 200 \Omega$   
 $R_L = 1 M\Omega \parallel 68 \text{ pF}$

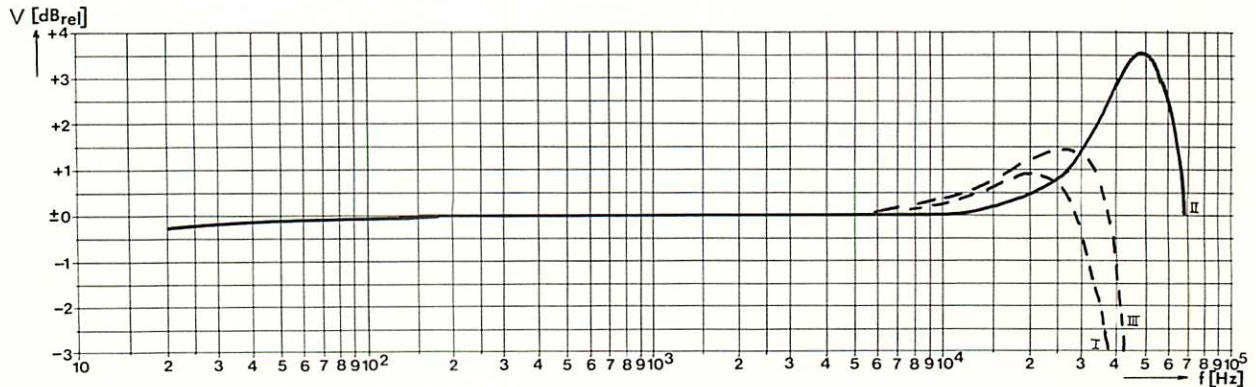

**TR/BV 351 010 005**

- Measurement with voltmeter
- I:  $R_G = 200 \Omega$   
 $R_L = 500 \text{ k}\Omega \parallel 100 \text{ pF}$
  - II:  $R_G = 200 \Omega$   
 $R_L = 500 \text{ k}\Omega \parallel 0 \text{ pF}$
  - III:  $R_G = 200 \Omega$   
 $R_L = 500 \text{ k}\Omega \parallel 68 \text{ pF}$

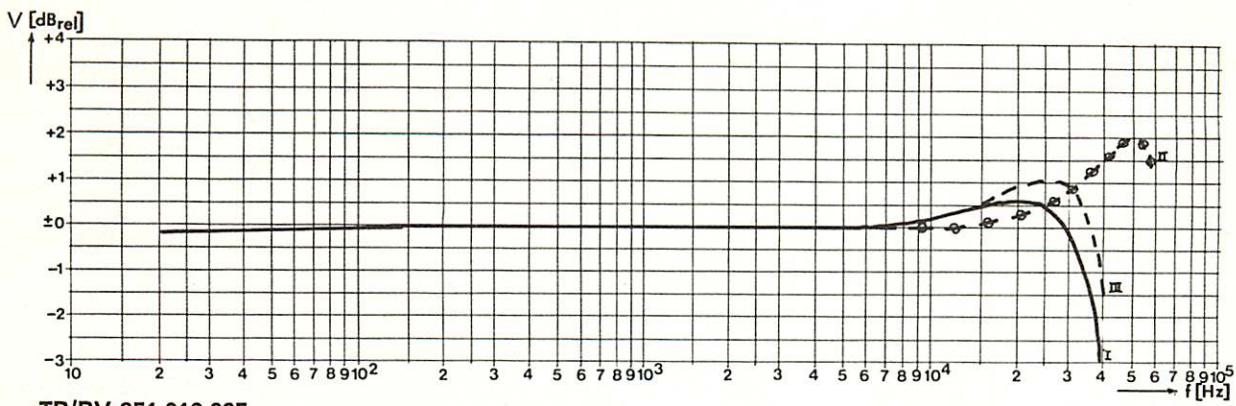

**TR/BV 351 010 005**

- I:  $R_G = 200 \Omega$   
 $R_L = 250 \text{ k}\Omega \parallel 100 \text{ pF}$
- II:  $R_G = 200 \Omega$   
 $R_L = 250 \text{ k}\Omega \parallel 0 \text{ pF}$
- III:  $R_G = 200 \Omega$   
 $R_L = 250 \text{ k}\Omega \parallel 68 \text{ pF}$

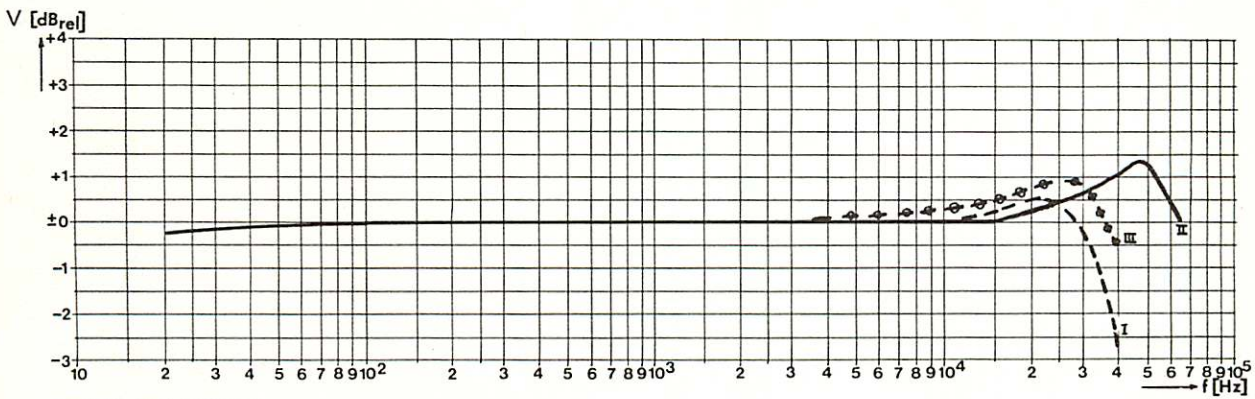

**TR/BV 351 010 005**

- I:  $R_G = 200 \Omega$   
 $R_L = 100 \text{ k}\Omega \parallel 100 \text{ pF}$
- II:  $R_G = 200 \Omega$   
 $R_L = 100 \text{ k}\Omega \parallel 0 \text{ pF}$
- III:  $R_G = 200 \Omega$   
 $R_L = 100 \text{ k}\Omega \parallel 68 \text{ pF}$

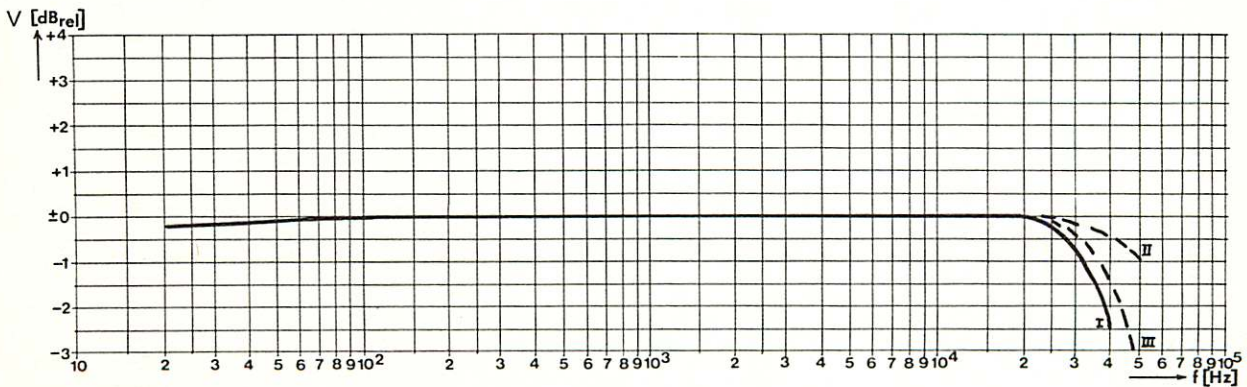

**TR/BV 351 010 005**

- I:  $R_G = 200 \Omega$   
 $R_L = 50 \text{ k}\Omega \parallel 100 \text{ pF}$
- II:  $R_G = 200 \Omega$   
 $R_L = 50 \text{ k}\Omega \parallel 0 \text{ pF}$
- III:  $R_G = 200 \Omega$   
 $R_L = 50 \text{ k}\Omega \parallel 68 \text{ pF}$

An increase of the generator impedance will additionally influence the low frequency response.

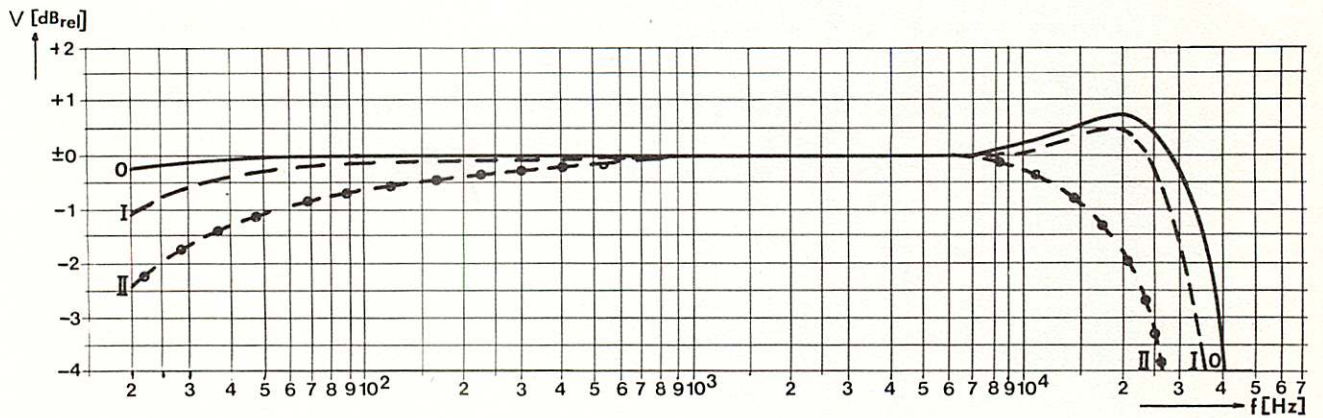

- 0:  $R_g = 200\Omega$                     open secondary
- I:  $R_g = 600\Omega$   
 $R_L = 500\text{ k}\Omega \parallel 200\text{ pF}$  [voltmeter + measuring cable]
- II:  $R_g = 1\,200\Omega$   
 $R_L = 500\text{ k}\Omega \parallel 200\text{ pF}$  [voltmeter + measuring cable]

Furthermore, an increase of the generator impedance relative to the given  $R_{gen\ nominal}$  will also lead to an increased distortion factor THD in accordance with the following approximate formula:

$$(f) \approx THD_{nominal}(f) \cdot \sqrt{\frac{R_{gen\ real}}{R_{gen\ nominal}}}$$

$THD_{nominal}(f)$  can be obtained from the curve opposite.

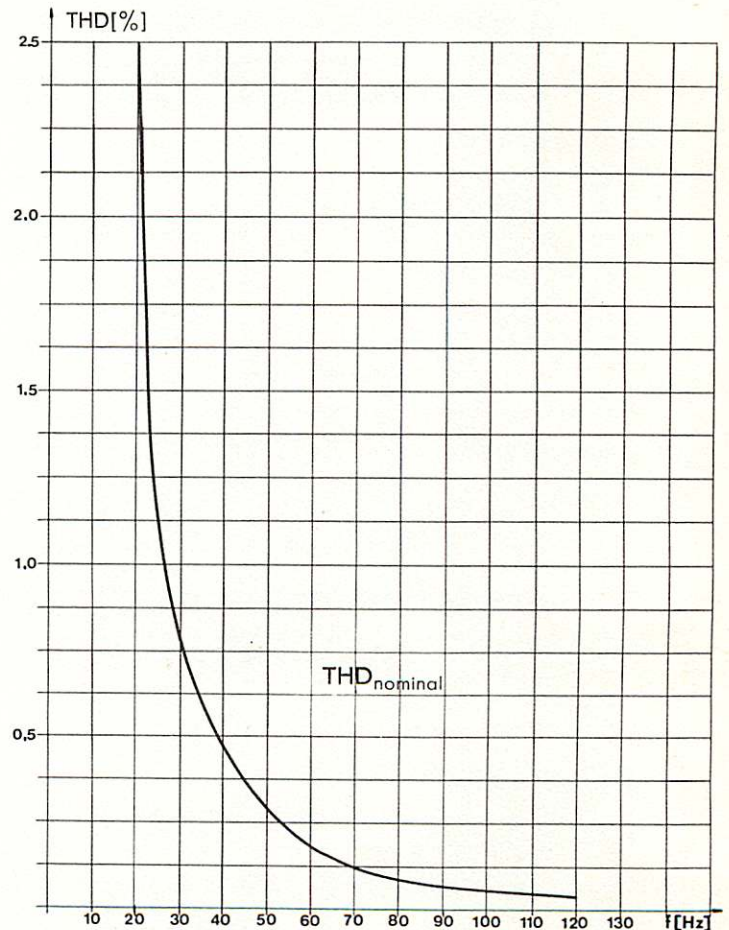



# STUDIO GRADE TRANSFORMERS

Mechanically mounted transformers — construction of transformer group 35 (solder-in types with leads)

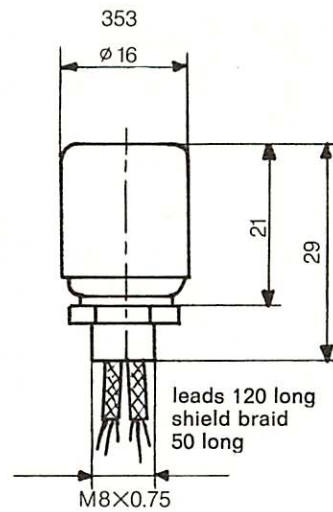
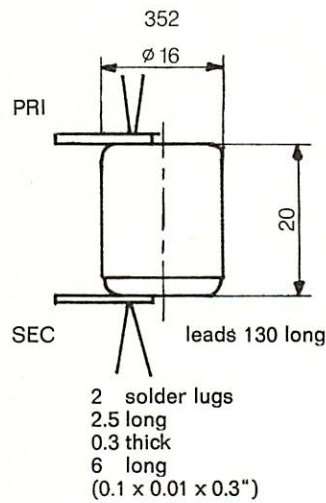
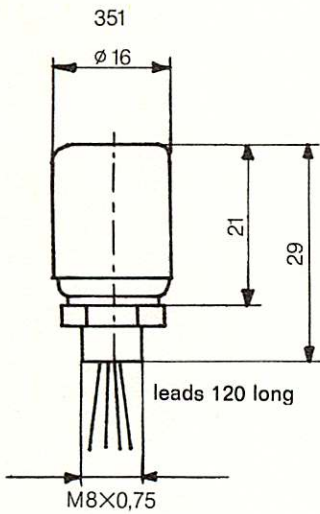

Plug-in transformers — construction of transformer group 36 (plug-in types with 7-pin miniature tube socket)

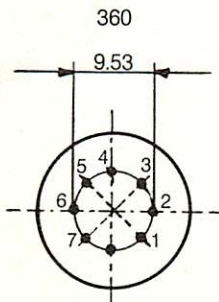

Third digit of the BV-number - pin connection:

0 = standard pin connection

single primary 360 0

- pin 1 primary end
- 2 NC
- 3 NC
- 4 primary start
- 5 case and static shield
- 6 secondary start
- 7 secondary end

Center-tapped primary 360 1

- pin 1 primary end
- 2 NC
- 3 primary CT
- 4 primary start
- 5 case and static shield
- 6 secondary start
- 7 secondary end

Two primary windings 360 2

- pin 1 primary II end
- 2 primary II start
- 3 primary I end
- 4 primary I start
- 5 case and static shield
- 6 secondary start
- 7 secondary end

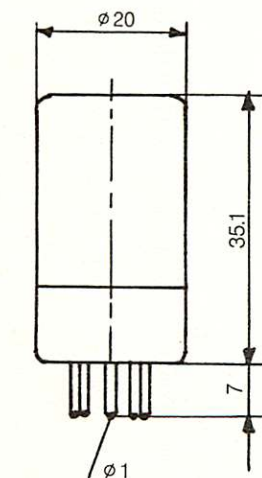

All dimensions in mm

# STUDIO GRADE TRANSFORMERS

Printed circuit mounted transformers — construction of transformer group 31.

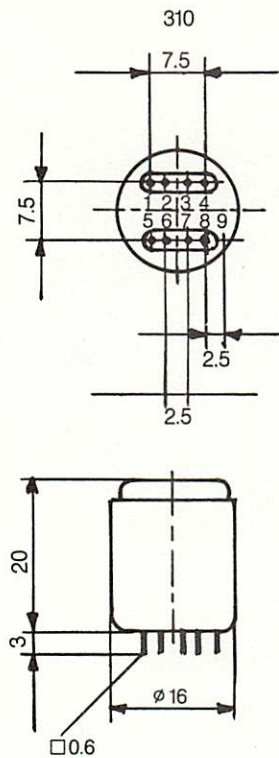

pin connections

0 = standard pin connection  
(third digit of the BV number)

single primary 310 0

- pin 1 primary start
- 2 NC
- 3 NC
- 4 primary end
- 5 secondary end
- 6 NC
- 7 secondary start
- 8 static shield
- 9 case

center-tapped primary 310 1

- pin 1 primary start
- 2 primary CT
- 3 NC
- 4 primary end
- 5 secondary end
- 6 NC
- 7 secondary start
- 8 static shield
- 9 case

two primary windings 310 2

- pin 1 primary I start
- 2 primary I end
- 3 primary II start
- 4 primary II end
- 5 secondary end
- 6 NC
- 7 secondary start
- 8 static shield
- 9 case

Printed circuit mounted transformers — construction of transformer group 37.

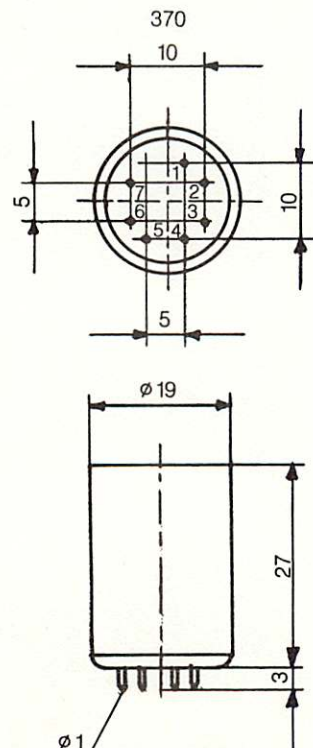

pin connections

0 = standard pin connection  
(third digit of the BV number)

single primary winding 370 0

- pin 1 secondary end
- 2 secondary start
- 3 case and static shield
- 4 primary start
- 5 NC
- 6 NC
- 7 primary end

center-tapped primary 370 1

- pin 1 secondary end
- 2 secondary start
- 3 case and static shield
- 4 primary start
- 5 primary CT
- 6 NC
- 7 primary end

two primary windings 370 2

- pin 1 secondary end
- 2 secondary start
- 3 case and static shield
- 4 primary I start
- 5 primary I end
- 6 primary II start
- 7 primary II end

All dimensions in mm

# STUDIO GRADE TRANSFORMERS

Printed circuit mounted transformers — construction of transformer group 38.

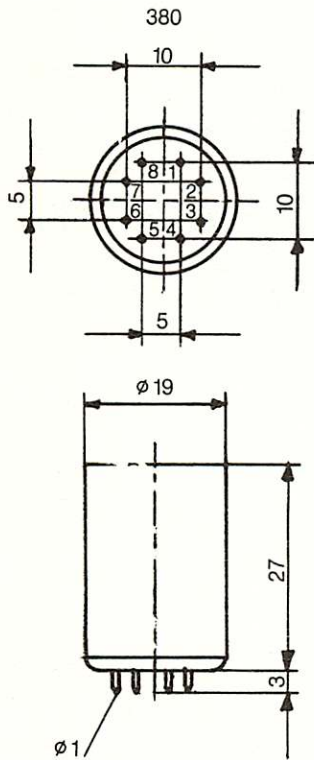

pin connections

0 = standard pin connection  
(third digit of the BV-number)

single primary 380 0

- pin 1 secondary end
- 2 secondary start
- 3 case
- 4 primary start
- 5 NC
- 6 NC
- 7 primary end
- 8 static shield

center-tapped primary 380 1

- pin 1 secondary end
- 2 secondary start
- 3 case
- 4 primary start
- 5 primary CT
- 6 NC
- 7 primary end
- 8 static shield

two primary windings 380 2

- pin 1 secondary end
- 2 secondary start
- 3 case
- 4 primary I start
- 5 primary I end
- 6 primary II start
- 7 primary II end
- 8 static shield

All dimensions in mm



TR/BV 351 ...



TR/BV 352 ...

# SUB-MINIATURE TRANSFORMERS

Construction of transformer group 75.  
(mechanically mounted transformers — solder-in types with leads)

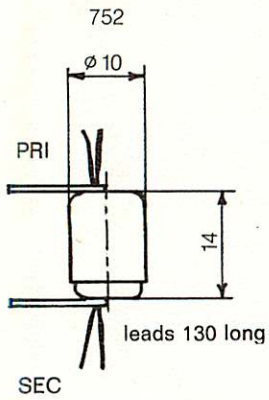

2 solder lugs

solder lugs 2.5 mm x 0.3 mm x 7.5 mm long (0.1 x 0.01 x 0.3")

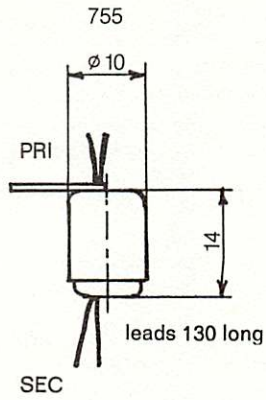

1 solder lug

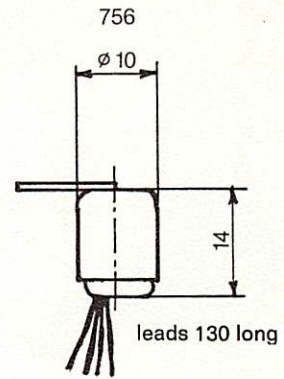

1 solder lug



TR/BV 752 . . .

# CABLE TRANSFORMERS

To match dynamic low impedance microphones to medium and high impedance amplifier inputs. These audio transformers are provided as ready to connect cable and plug-in transformers which are to be connected between the microphone or microphone cable and amplifier input.

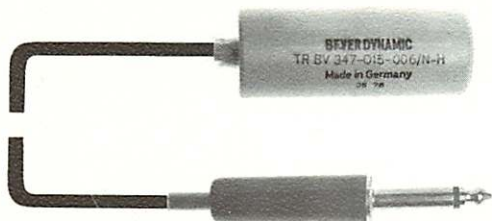

TR/BV 347 ... / N-K

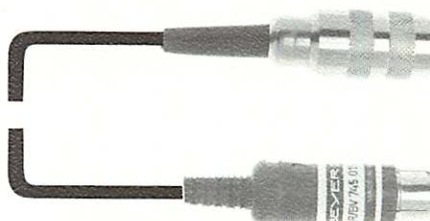

TR/BV 745 ... / N-H

type	turns ratio (impedance)	frequency range HZ	frequency response relative to 1 kHz	cable length	wiring
TR/BV 745 015 257/L-H/0.5	1:15 (200Ω/45kΩ)	50 — 15 000	-3/±2 dB	0.5 m	Mak 30, 2—3, Mas 30, 1—2
TR/BV 745 015 257/N-H/5	1:15 (200Ω/45kΩ)	50 — 15 000	-3/±2 dB	5.0 m	3 pole female screw connector 1—3, Mas 30, 1—2
TR/BV 347 001 001/N-L	1:1 (200Ω/200Ω)	30 — 15 000	± 1 dB	0.2 m	Mab 3, 1—3, Mas 30, 3—2
TR/BV 347 003 002/N-ML	1:3,16 (200Ω/2kΩ)	30 — 15 000	± 1 dB	0.2 m	Mab 3, 1—3, Mas 30, 3/1—2
TR/BV 347 005 003/N-H	1:5 (200Ω/5kΩ)	30 — 15 000	± 1 dB	0.2 m	Mab 3, 1—3, Mas 30, 1—2
TR/BV 347 015 006/N-H	1:15 (200Ω/45kΩ)	30 — 15 000	± 1 dB	0.2 m	Mab 3,1—3, Mas 30, 1—2
TR/FV 347 015 006/N-K	1:15 (200Ω/45kΩ)	30 — 15 000	± 1 dB	0.2 m	Mab 3, 1—3, jack plug 6.35 Ø
TR/BV 347 020 007/N-Ci	1:20 (200Ω/80kΩ)	30 — 15 000	± 1 dB	0.2 m	Mab 3, 1—3, Cinch plug
TR/BV 345 015 006/C-K/5	1:15 (200Ω/45kΩ)	30 — 15 000	± 1 dB	5.0 m	Switchcraft female connector jack plug 6.35 Ø

# PLUG-IN TRANSFORMERS



TR/BV 741 ... / N-K

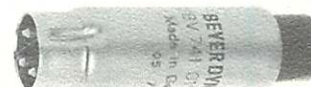

TR/BV 741 ... / N-H

type	turns ratio (impedance)	frequency range HZ	frequency response relative to 1 kHz	wiring
TR/BV 741 003 276/N-K	1:3.16 (500Ω/5kΩ)	50 — 15 000	-3/±2 dB	Mab 3, 1—3, jack plug 6.35 Ø
TR/BV 741 005 252/N-K	1:5 (200Ω/5kΩ)	50 — 15 000	-3/±2 dB	Mab 3, 1—3, jack plug 6.35 Ø
TR/BV 741 015 257/N-H	1:15 (200Ω/45kΩ)	50 — 15 000	-3/±2 dB	Mab 3, 1—3, Mas 30, 1—2
TR/BV 741 015 257/N-K	1:15 (200Ω/45kΩ)	50 — 15 000	-3/±2 dB	Mab 3, 1—3, jack plug 6.35 Ø
TR/BV 741 010 278/N-K	1:10 (500Ω/50kΩ)	50 — 15 000	-3/±2 dB	Mab 3, 1—3, jack plug 6.35 Ø
TR/BV 341 015 006/C-C	1:15 (200Ω/45kΩ)	30 — 15 000	± 1 dB	Switchcraft female connector- Switchcraft male connector

# TRANSFORMERS - STANDARD PROGRAM

The following models of our standard program are stock items:

type	turns ratio (impedance)	frequency range Hz	frequency response relative to 1 kHz	remarks
studio quality transformer chassis single threaded stud mount				
TR/BV 351 001 001	1:1 (200Ω/200Ω)	30 — 15 000 Hz	± 1 dB	
TR/BV 351 003 002	1:3.16 (200Ω/2kΩ)	30 — 15 000 Hz	± 1 dB	
TR/BV 351 005 003	1:5 (200Ω/5kΩ)	30 — 15 000 Hz	± 1 dB	
TR/BV 351 007 004	1:7 (200Ω/10kΩ)	30 — 15 000 Hz	± 1 dB	
TR/BV 351 010 005	1:10 (200Ω/20kΩ)	30 — 15 000 Hz	± 1 dB	
TR/BV 351 015 006	1:15 (200Ω/45kΩ)	30 — 15 000 Hz	± 1 dB	
TR/BV 351 020 007	1:20 (200Ω/80kΩ)	30 — 15 000 Hz	± 1 dB	
studio transformers, chassis single threaded stud mount, special types				
TR/BV 351 001 081	1:1 (1kΩ/1kΩ)	30 — 15 000 Hz	± 0,5 dB	
TR/BV 353 001 081	1:1 (1kΩ/1kΩ)	30 — 15 000 Hz	± 0,5 dB	shielded leads
studio transformers, solder lug mounting				
TR/BV 352 001 001	1:1 (200Ω/200Ω)	30 — 15 000 Hz	± 1 dB	
TR/BV 352 003 002	1:3,16 (200Ω/2kΩ)	30 — 15 000 Hz	± 1 dB	
TR/BV 352 005 003	1:5 (200Ω/5kΩ)	30 — 15 000 Hz	± 1 dB	
TR/BV 352 007 004	1:7 (200Ω/10kΩ)	30 — 15 000 Hz	± 1 dB	
TR/BV 352 010 005	1:10 (200Ω/20kΩ)	30 — 15 000 Hz	± 1 dB	
TR/BV 352 015 006	1:15 (200Ω/45kΩ)	30 — 15 000 Hz	± 1 dB	
TR/BV 352 020 007	1:20 (200Ω/80kΩ)	30 — 15 000 Hz	± 1 dB	
sub-miniature transformers with two solder lugs, leads brought out two ends				
TR/BV 752 003 276	1:3,16 (500Ω/5kΩ)	50 — 15 000 Hz	— 3 / ± 2 dB	
TR/BV 752 005 252	1:5 (200Ω/5kΩ)	50 — 15 000 Hz	— 3 / ± 2 dB	
TR/BV 752 010 278	1:10 (500Ω/50kΩ)	50 — 15 000 Hz	— 3 / ± 2 dB	
TR/BV 752 015 257	1:15 (200Ω/45kΩ)	50 — 15 000 Hz	— 3 / ± 2 dB	

# COLOR CODING OF LEADS

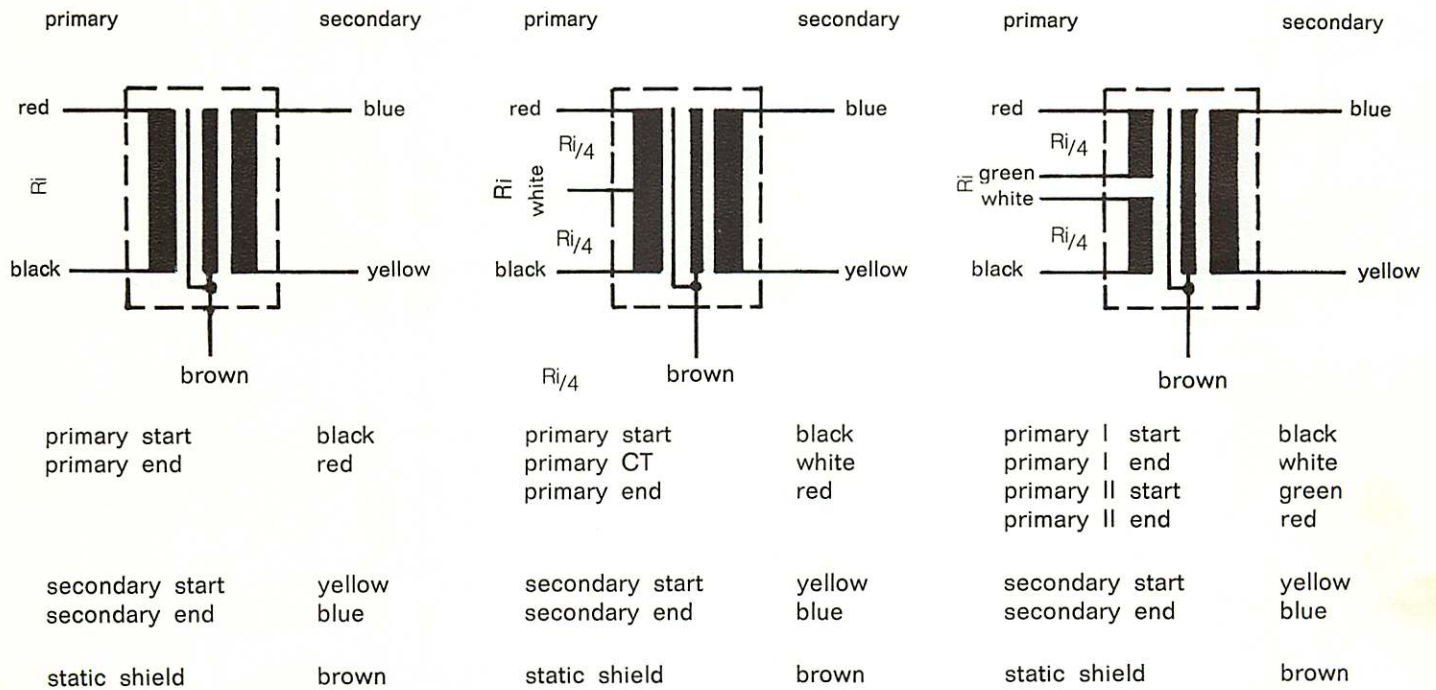

$R_i$ : transformer input impedance

turns ratio: 1 : 30 (200 Ω / 180 kΩ)

**type:** BV 3 . . . 0 30 021

primary secondary

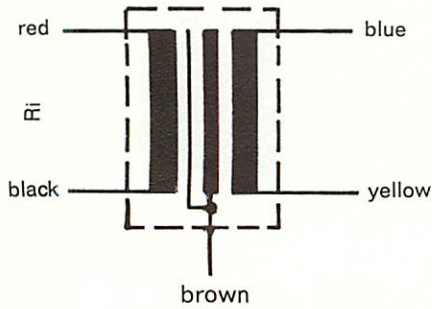

primary start	black
primary end	red
secondary start	yellow
secondary end	blue
static shield	brown

**type:** BV 3 . . . 1 30 021

primary secondary

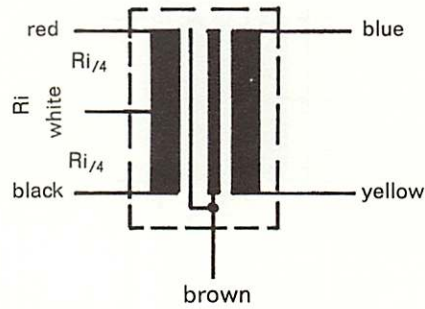

primary start	black
primary CT	white
primary end	red
secondary start	yellow
secondary end	blue
static shield	brown

**type:** 3 . . . 2 30 021

primary secondary

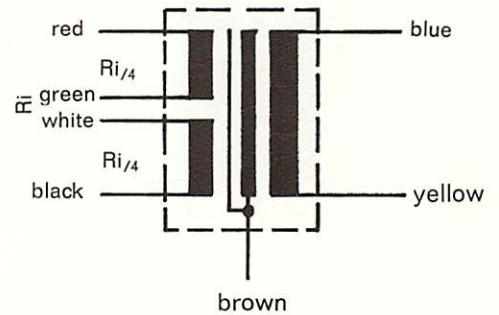

primary I start	black
primary I end	white
primary II start	green
primary II end	red
secondary start	yellow
secondary end	blue
static shield	brown

Ri: transformer input impedance

### Technical data

Construction:	all versions of the group 3 . .
Turns ratio (impedance):	1 : 30 ± 10 % (200 Ω : 180 kΩ) (black-red/yellow-blue)
Frequency response for a source impedance of 200 ohms relative to 1 kHz secondary unterminated:	40 — 15 000 Hz ± 1 dB
Maximum input level for 1 % THD:	typ. 100 mV at 40 Hz
Primary open circuit inductance:	typ. 2.8 H at 50 Hz (black-red)
Primary open circuit impedance:	typ. 880 Ω at 50 Hz (black-red)
Primary DC resistance:	typ. 56 Ω (black-red)
Secondary DC resistance:	typ. 14.5 kΩ



turns ratio: 1 : 1 (200 Ω / 200 Ω)

**type:** BV 3 . . . 0 01 022

**type:** BV 3 . . . 1 01 022

**type:** BV 3 . . . 2 01 022

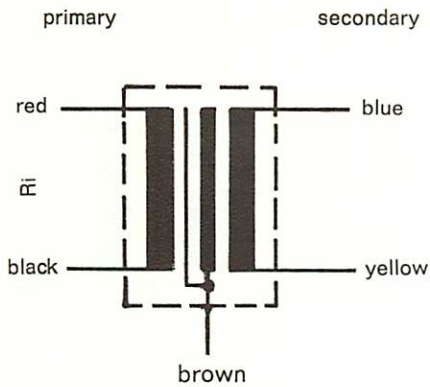

primary start      black  
primary end        red

secondary start    yellow  
secondary end      blue

static shield        brown

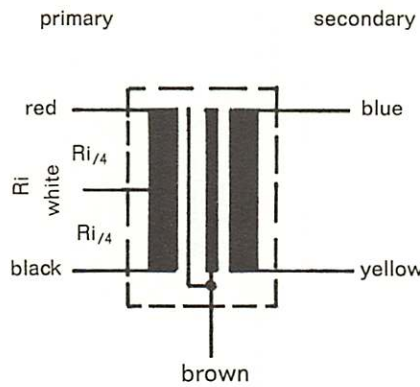

primary start      black  
primary CT        white  
primary end        red

secondary start    yellow  
secondary end      blue

static shield        brown

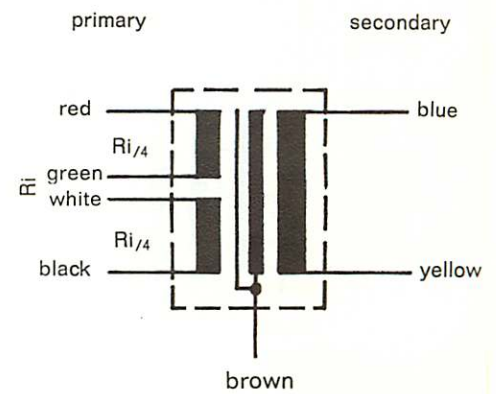

primary I start    black  
primary I end      white  
primary II start    green  
primary II end      red

secondary start    yellow  
secondary end      blue

static shield        brown

Ri: transformer input impedance

## Technical data

Construction: all versions of the group 3 . .

Turns ratio (impedance): 1 : 1 ± 10 %

Frequency response for a source impedance of 200 ohms relative to 1 kHz secondary unterminated: 30 - 15 000 Hz ± 1 dB

Maximum input level for 1 % THD: 1.5 V at 30 Hz

Primary open circuit inductance: approx. 80 H at 50 Hz (black-red)

Primary open circuit impedance: approx. 25 kΩ at 50 Hz (black-red)

Primary DC resistance: approx. 700 Ω (black-red)

Secondary DC resistance: approx. 1.03 kΩ

# SPECIAL TRANSFORMERS

turns ratio: 1 : 1 (1 k $\Omega$  / 1 k $\Omega$ )

**type:** BV 3...0 01 081

primary

secondary

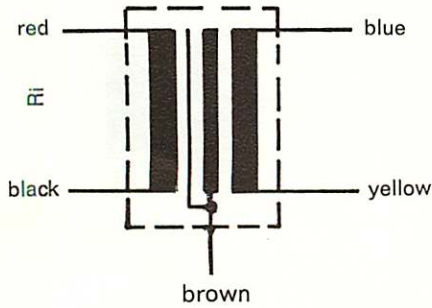

primary start  
primary end

black  
red

secondary start  
secondary end

yellow  
blue

static shield

brown

**type:** BV 3...1 01 081

primary

secondary

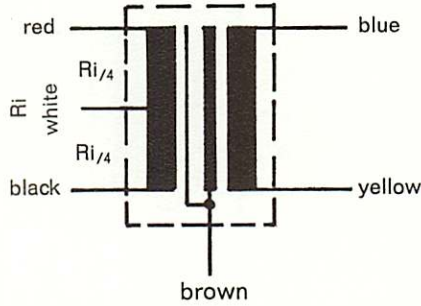

primary start  
primary CT  
primary end

black  
white  
red

secondary start  
secondary end

yellow  
blue

static shield

brown

**type:** BV 3...2 01 081

primary

secondary

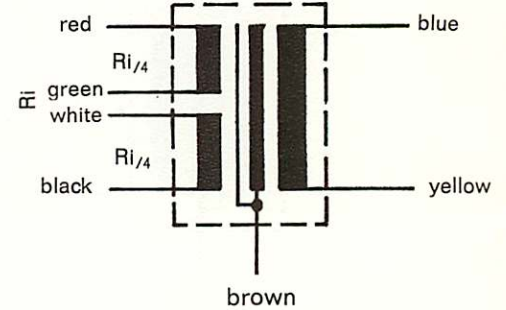

primary I start  
primary I end  
primary II start  
primary II end

black  
white  
green  
red

secondary start  
secondary end

yellow  
blue

static shield

brown

Ri: transformer input impedance

## Technical data

Construction:	all versions of group 3...
Turns ratio (impedance):	1 : 1 attenuation 3 dB
Frequency response for a source impedance of 1000 $\Omega$ relative to 1 kHz (secondary loaded with 50 k $\Omega$ ):	30 — 15 000 Hz $\pm$ 0,5 dB
Maximum input level for 1 % THD:	8 V at 30 Hz
Primary open circuit inductance:	approx. 1000 H at 50 Hz (black-red)
Primary open circuit impedance:	approx. 314 k $\Omega$ at 50 Hz (black-red)
Primary DC resistance:	approx. 5.9 k $\Omega$ (black-red)
Secondary DC resistance:	approx. 7.9 k $\Omega$

## How to choose the most suitable transformer.

### 1. Application

- |                                   |                                     |                        |                                     |                      |                                     |                     |                          |
|-----------------------------------|-------------------------------------|------------------------|-------------------------------------|----------------------|-------------------------------------|---------------------|--------------------------|
| Mechanically mounted transformers | <input checked="" type="checkbox"/> | threaded stud mounting | <input type="checkbox"/>            | plug in mounting     | <input type="checkbox"/>            | solder lug mounting | <input type="checkbox"/> |
| Plug-in transformers              | <input type="checkbox"/>            | DIN input              | <input type="checkbox"/>            | DIN output           | <input type="checkbox"/>            |                     |                          |
| Cable transformers                | <input type="checkbox"/>            | jack input             | <input type="checkbox"/>            | jack output          | <input type="checkbox"/>            |                     |                          |
|                                   |                                     | cinch (phono) input    | <input type="checkbox"/>            | cinch (phono) output | <input type="checkbox"/>            |                     |                          |
|                                   |                                     | balanced               | <input checked="" type="checkbox"/> | unbalanced           | <input type="checkbox"/>            |                     |                          |
|                                   |                                     |                        |                                     | leads not shielded   | <input type="checkbox"/>            |                     |                          |
|                                   |                                     |                        |                                     | shielded             | <input checked="" type="checkbox"/> |                     |                          |

2. Single primary winding
- Center tapped primary
- Split bifilar wound primary

### 3. Turns ratio

4. Primary impedance of approx. .... ohms at 50 Hz

5. Frequency response (minimum from ..... to ..... Hz  $\pm$  ..... dB

### 6. Maximum input voltage

7. Primary open circuit inductance H
8. Primary open circuit impedance ohms
9. DC resistance primary max. ohms
- DC resistance secondary max. ohms

10. Quantity involved per order / per year (approx.).

## **Manufacturing program:**

Dynamic Moving Coil Microphones  
Dynamic Ribbon Microphones  
Condenser microphones  
Wireless microphones transistophone®  
Dynamic Headphones  
Infrared sound transmission  
Accessories  
Mounting and cable transformers

## **Fertigungsprogramm:**

Dynamische Tauchspulenmikrofone  
Dynamische Bändchenmikrofone  
Kondensatormikrofone  
Drahtlose Mikrofonanlage transistophone®  
Dynamische Kopfhörer  
Mikrofon- und Kopfhörer-Zubehör  
Miniaturübertrager  
Infrarot-Tonübertragung

## **Programme de fabrication:**

Microphones électrodynamiques à bobine mobile  
Microphones électrodynamiques à ruban  
Microphone à condensateur  
Ensemble microphone-émetteurs / récepteur transistophone® HF  
Ecouteurs électrodynamiques  
Accessoires  
Transformateurs d'impédance miniaturisés  
Transmission par infrarouges

# **G O T H A M**

741 Washington Street, New York, NY 10014 ☎ (212) 741-7411

**BEYER DYNAMIC**